

Development of fish screening criteria for water diversions in the Murray-Darling Basin

Craig Boys, Lee Baumgartner, Ben Rampano, Wayne Robinson, Trent Alexander, Gary Reilly, Mark Roswell, Tony Fowler and Michael Lowry



NSW Department of Primary Industries
Port Stephens Fisheries Institute
Locked Bag 1,
Nelson Bay NSW 2315

June 2012

Fisheries Final Report Series
No. 134
ISSN 1837-2112



Department of Primary Industries
&
Namoi Catchment Management Authority



**Development of fish screening criteria for water diversions in the
Murray-Darling Basin**

Craig Boys, Lee Baumgartner, Ben Rampano, Wayne Robinson, Trent
Alexander, Gary Reilly, Mark Roswell, Tony Fowler and Michael Lowry

NSW Department of Primary Industries
Port Stephens Fisheries Institute
Locked Bag 1,
Nelson Bay NSW 2315

Development of fish screening criteria for water diversions in the Murray-Darling Basin

March 2012

Authors: Craig Boys, Lee Baumgartner, Ben Rampano, Wayne Robinson, Trent Alexander, Gary Reilly, Mark Roswell, Tony Fowler and Michael Lowry.
Published By: Industry and Investment NSW
Postal Address: PO Box 21 Cronulla NSW 2230
Internet: www.dpi.nsw.gov.au

© NSW Department of Primary industries and Murray-Darling Basin Authority

This work is copyright. Graphical and textual information in the work (with the exception of photographs and departmental logos) may be stored, retrieved and reproduced in whole or in part, provided the information is not sold or used for commercial benefit and its source (*Development of fish screening criteria for water diversions in the Murray-Darling Basin*) is acknowledged. Such reproduction includes fair dealing for the purpose of private study, research, criticism or review as permitted under the Copyright Act 1968. Reproduction for other purposes is prohibited without prior permission of the Murray-Darling Basin Authority, NSW DPI or the individual photographers and artists with whom copyright applies.

DISCLAIMER

The publishers do not warrant that the information in this report is free from errors or omissions. The publishers do not accept any form of liability, be it contractual, tortious or otherwise, for the contents of this report for any consequences arising from its use or any reliance placed on it. To the extent permitted by law, the copyright holders (including its employees and consultants) exclude all liability to any person for any consequences, including but not limited to all losses, damages, costs, expenses and any other compensation, arising directly or indirectly from using this report (in part or in whole) and any information or material contained in it.

ISSN 1837-2112

Note: Prior to July 2004, this report series was published by NSW Fisheries as the 'NSW Fisheries Final Report Series' with ISSN number 1440-3544. Then, following the formation of the NSW Department of Primary Industries the report series was published as the 'NSW Department of Primary Industries – Fisheries Final Report Series' with ISSN number 1449-9967. The report series is now published by Industry & Investment NSW as the 'Industry & Investment NSW – Fisheries Final Report Series' with ISSN number 1837-2112.

TABLE OF CONTENTS

TABLE OF CONTENTS	IV
LIST OF FIGURES	VI
LIST OF TABLES	VIII
LIST OF TABLES	VIII
ACKNOWLEDGEMENTS	IX
KEY TERMS AS DEFINED IN THIS REPORT	X
NON-TECHNICAL SUMMARY	XI
1. GENERAL INTRODUCTION	1
1.1 BACKGROUND	1
1.2 PURPOSE OF THIS STUDY	2
2. OPTIMISING FISH SCREEN DESIGN CRITERIA USING A FIELD-BASED APPROACH: EFFECT OF MESH SIZE AND APPROACH VELOCITY	3
2.1 INTRODUCTION	3
2.2 METHODS	4
2.2.1. <i>Study area</i>	4
2.2.2. <i>Experimental pumping station</i>	6
2.2.3. <i>Fish community surveys</i>	6
2.2.4. <i>Quantifying entrainment</i>	10
2.2.5. <i>Quantifying screen contact</i>	10
2.3 RESULTS	13
2.3.1. <i>Fish entrainment</i>	13
2.3.2. <i>Screen contact</i>	13
2.4 DISCUSSION	19
2.4.1. <i>Optimising screen design for the Murray-Darling Basin</i>	19
2.4.2. <i>Effectiveness of the dual approach for field evaluations</i>	20
2.4.3. <i>Conclusion</i>	20
3. EFFECT OF VELOCITY AND LIGHT ON THE ENTRAINMENT AND IMPINGEMENT OF JUVENILE GOLDEN PERCH AND SILVER PERCH AT A SIMULATED INTAKE SCREEN	22
3.1 INTRODUCTION	22
3.2 METHODS	23
3.2.1. <i>Fish collection and holding</i>	23
3.2.2. <i>Experimental apparatus</i>	23
3.2.3. <i>Intake experiments</i>	24
3.2.4. <i>Statistical analysis</i>	25
3.3 RESULTS	31
3.4 DISCUSSION	36
4. REVIEW OF FISH SCREENING PROGRAMS IN THE UNITED STATES OF AMERICA: LESSONS FOR THE MURRAY-DARLING BASIN.	38
4.1 INTRODUCTION	38
4.2 DO WE KNOW ENOUGH ABOUT THE EXTENT OF THE PROBLEM IN THE MURRAY-DARLING BASIN TO BEGIN ACTION?	38
4.3 AN EVIDENCE BASED APPROACH TO DEVELOPING SCREEN DESIGN CRITERIA.....	39
4.4 APPLYING EXISTING TECHNOLOGIES IN THE APPROPRIATE CONTEXT.....	40
4.5 MAXIMISING ADOPTION	44
4.6 CO-ORDINATION	45

4.7	MAINTENANCE IS AN IMPORTANT FACTOR OF ANY SCREENING PROGRAM	45
4.8	CONCLUSION AND RECOMMENDATIONS	46
5.	CONCLUSION AND FINAL RECOMMENDATIONS	47
6.	REFERENCES.....	49

LIST OF FIGURES

Figure 1. Location of the four study sites on the Namoi River showing the Murray-Darling Basin (grey thatched).....	5
Figure 2. Picture of the experimental pumping station showing typical deployment into water adjacent to a gravel bar.....	5
Figure 3. Schematic representation of the experimental pumping station used in the Namoi River showing major components. The experimental screen was cylindrical and comprised a series of removable panels to adjust approach velocity and mesh size. Fish that were entrained into the system travelled through the intake pipe, through the pump, along the lay-flat discharge pipe and were collected in fyke nets retrofitted to a settling tank. Fish behaviour in front of the screen face was quantified using DIDSON.....	7
Figure 4. Experimental fish screen showing removable mesh screen panels. These could be removed and replaced with panels of different mesh size. Some were replaced with aluminium blanks to manipulate approach velocity.....	8
Figure 5. Diagram of the experimental fish screen showing position of mesh screen panels (M) and position of DIDSON for the a) 0.1 m/sec approach velocity, b) 0.5 m/sec approach velocity. Degrees are relative to 0° facing directly into downstream flow (indicated by the arrow). Note the position of blank panels (those not marked with M). To achieve the maximum velocity of 0.5 m.s ⁻¹ all panels except two needed to be fitted with blanks.....	9
Figure 6. Screenshot showing acoustic echogram obtained from the DIDSON (a) alongside post-processing modules created in Echoview, including a background reduction and target identification module (b) and fish tracking module (c). Screen panels can be seen as light coloured bands at the image bottom.....	12
Figure 7. Length frequency histograms for fish sampled at pumping sites by electrofishing and seine netting, and those collected after being entrained by the pump (all treatments pooled).....	16
Figure 8. Mean (\pm S.E.) Cath per unit effort (CPUE) of fish across different mesh and velocity treatments.....	16
Figure 9. Length frequency histogram showing the size range of fish observed by DIDSON to make contact or avoid contact with the experimental screen.....	17
Figure 10. Predicted relationship of probability of screen contact with length and rheotaxis of fish. Solid lines are at 0.1 m/sec and broken lines are at 0.5 m/sec.....	18
Figure 11. Overview of experimental setup showing the holding tank (left) and test tank (right) containing the flume (inset). Ambient light was excluded from the flume using black plastic and supplemented with either infrared light (zero light treatments) or a 40 watt incandescent light (lighted treatment).....	26
Figure 12. Experimental flume with a) cradle removed and b) cradle <i>in situ</i> with side wall cut away for viewing. All dimensions in mm.....	27
Figure 13. Velocity profile in the flume showing decreasing velocity perpendicular to the screen with increasing distance from screen. Profiles are shown for the different slot velocity (SV) treatments. The vertical lines signify the various approach velocities (AV) (measured 8 cm from the screen face) for each SV.....	29
Figure 14. Examples of behaviours commonly observed: a) an approach, b) a contact (< 3 sec) or impingement (prolonged contact \geq 3 sec), and c) a school of fish displaying positive rheotactic behaviour in front of the screen face.....	30
Figure 15. Mean (\pm SE) rate that a) silver perch and b) golden perch approached the experimental screen across the various slot (SV) or approach (AV) velocities (m/sec) and no screen treatment. Different letters represent significantly different	

treatments ($p < 0.05$) determined by pairwise comparisons. Note the different scales on the y axis.32

Figure 16. Mean (\pm SE) probability of screen contact and impingement resulting from a screen approach in a) silver perch and b) golden perch, between the different slot (SV) or approach (AV) velocities (m/sec). Where an overall significant treatment effect was found, significantly different groups ($p < 0.05$), determined by pairwise comparisons, are indicated by differing letters.32

Figure 17. Mean (\pm SE) percentage of fish showing signs of injuries (24 hr post experiment) for each slot (SV) or approach (AV) velocity compared to the handling control. Results of one-way permutational ANOVA shown.33

Figure 18. Mean (\pm SE) approach rate (a) and probability that an approach resulted in a contact (b) or impingement (c) for silver perch (left) and golden perch (right) for different slot (SV) or approach (AV) velocities (AV, m/sec) and light (Li) treatments. Significance levels of main-effects ANOVA are shown for each factor and interaction (detailed in Table 10). Where Li was found to be significant, pairwise comparisons for each pair of Li within each AV was conducted and significance level indicated above the bars. Significant at * $P < 0.05$, ** $P < 0.01$, NS: non significant.34

Figure 19. Various screen designs for potential application in the Murray-Darling Basin. (a) rotary drum screen, (b) rotating pump screen with rotating head and internal jet, (c) travelling belt screen, (d) vertical panel screen (submerged) with travelling brush and (e & f) brushed cylinder pump screen (e & f reproduced with permission of Intake Screens, Inc.).43

LIST OF TABLES

Table 1. Coordinates of the four pumping sites used during the study.	4
Table 2. Tabular representation of the two Latin square experimental designs showing the allocation of mesh treatments within replicate runs for each of two approach velocities.	8
Table 3. Odds ratios for probability of screen contact for different mesh sizes when compared to the no mesh treatment at 0.1 m/sec.	14
Table 4. Number of fish entrained within the experimental pump system. Catches are pooled within each velocity and mesh combination. The electrofishing/seine column demonstrates the composition and relative abundance of fish captured at all the experimental site using electrofishing and seine netting.	15
Table 5. Odds Ratios of rheotactic categories compared to random orientation.	18
Table 6. Summary of water quality in holding and test tanks during the study.	28
Table 7. Experimental design showing the number of replicate test groups allocated to each slot (SV) or approach (AV) velocity treatment and tested in either no light or low-light conditions. ‘No light’ refers to experiments at 0 lux, ‘low light’ refers to experiments at 1 lux.	28
Table 8. Number of silver perch and golden perch dead or showing signs of injury within 24 hours of experimentation. The ‘no screen’ treatment has been excluded.	33
Table 9. Correlations between the number of fish injured and the contact and impingement rate of silver and golden perch exposed to the simulated intake screen.	33
Table 10. ANOVA results partitioning variance of the factors light and approach velocity and the interaction of these, for approach rate and the probability of approaches resulting in contacts and impingements, for both silver perch and golden perch.	35
Table 11. Fish Diversion screens with high potential for direct application in the Murray-Darling Basin.	41

ACKNOWLEDGEMENTS

The Murray-Darling Basin Authority (through the Native Fish Strategy Initiative), Cooperative Research Centre for Cotton Communities and Catchments, Namoi Catchment Management Authority and New South Wales Department of Primary Industries jointly funded this research project.

The project was overseen by a steering committee who gave generously of their time to review the experimental protocols and manuscript: including Martin Mallen-Cooper, Adam Vey, Cameron Lay, Garry Giddings, Guy Roth, Jane Macfarlane, Janet Pritchard and Heleena Bamford. Garry Giddings was particularly instrumental in the design and engineering of the experimental apparatus used in the field.

Landholders around Narrabri generously provided access to their properties and hosted field teams for the duration of the project. We would particularly like to thank Ken Fraiter and Dennis Smith. The research team is enormously grateful to irrigators and interested stakeholders who attended a public meeting in Narrabri to provide comment and advice regarding the initial experimental design and approach. The collaborative effort of the community has been instrumental to the success of this project.

Invaluable assistance was provided by Colin Barnes and his staff at BnB Engineering Narrabri, who engineered the field screens and coordinated the leasing and movement of the pumping station between sites. We are also grateful to Glenn Lein for his expert excavator skills that enabled the experimental pump to be moved and placed with enormous precision.

Various NSW DPI staff contributed to make this project a success. Graham Housefield and Nick Otway were extremely generous in providing time and equipment to facilitate the running of the lab-based trials at Port Stephens Fisheries Institute. Matthew McClellan of the Narrandera Fisheries Centre was responsible for the rearing, collection and delivery of hatchery-bred fish that were used in the lab trials.

The authors are indebted to Alan Ritchey (Oregon Department of Fish and Wildlife, Fish Screening Program Coordinator) who provided access to screening facilities in the Pacific Northwest (USA) and whose advice was pivotal in refining the lab experiments and developing recommendations for initiating a fish screening program for the Murray-Darling Basin. We would also like to thank Les Perkins from the Farmers Conservation Alliance who allowed us to tour farmers' screens in Oregon and also provided detailed design information. None of the scoping activities related to screening programs in the USA would have been possible without the efforts of David Marvin, who assisted in facilitating site visits and stakeholder meetings. Darryl Hayes of Intake Screens Inc. Sacramento provided photos of cylindrical brushed screens for this report.

All work in this project was carried out under ACEC authority (ACEC 04/08) and field sampling was undertaken under a Section 37 Scientific Research Collection permit P01/0059(A).

Members of the project steering committee, Native Fish Advisory Panel and Bob Creese provided comments on drafts of this report. Tracey McVea organised final formatting and printing.

KEY TERMS AS DEFINED IN THIS REPORT

Approach velocity: Velocity of water flowing in the vector perpendicular to, and *in front of*, the screen face. As velocity decline steadily with increasing distance from the screen, approach velocity in this report was measured 8 cm (3 inches) in front of the screen, which is typical of screening guidelines throughout the world.

Contact: when a fish touches a screen, in either a temporary or prolonged manner.

Design criteria: Aspects of a screens design which interact to impact a fish's ability to avoid entrainment or contact at a screen. These typically cover factors such as screening mesh type or size and velocities generated at the screen.

Entrainment: When a fish is pulled or drawn into an intake.

Fish screen: A device used to direct fish away from a water diversion, thereby reducing rates of fish entrainment whilst still allowing water to be delivered to where it is required.

Impingement: A type of screen contact where a fish is held against the screen face for a prolonged period. In this study this was defined as > 3 second.

Screen porosity: The percentage of the screen face that is 'open' or porous to provide passage of water. This is typically expressed as percent open area of screen face.

Screen mesh type/size: Refers to the material used to construct a fish screen and relates to the type of material used (e.g. wedge wire or perforated metal) and the porosity or size of the apertures that give the screen its porosity.

Slot velocity: In contrast to approach velocity, slot velocity refers to water as it passes *through the screen*. Because velocity decreases rapidly with increasing distance from the screen face, a given slot velocity will correspond to a smaller approach velocity (see above). In its simplest form, slot velocity is a function of discharge through the intake, screen surface area, and screen porosity (see above).

Sweeping velocity: Velocity of water flowing parallel to, and *in front of*, the screen face.

Water intake, offtake or diversion: A specific point in a river where water is abstracted from the channel.

NON-TECHNICAL SUMMARY

Development of fish screening criteria for water diversions in the Murray-Darling Basin

PRINCIPAL INVESTIGATOR: Dr Craig Boys

ADDRESS: Port Stephens Fisheries Institute
Locked Bag 1
Nelson Bay, NSW, 2315, AUSTRALIA
Telephone: +61 2 4982 1232 Fax: + 61 2 4982 2265
e-mail: craig.boys@dpi.nsw.gov.au

OBJECTIVES:

- To undertake experiments to develop physical design criteria for fish screens at water diversions in the Murray-Darling Basin.
- Undertake a scoping study of fish screening programs elsewhere in the world and make recommendations as to how to best initiate a similar program in the Murray-Darling Basin.

NON TECHNICAL SUMMARY:

Native fish populations in the Murray-Darling Basin are estimated at 10 % of pre-European settlement levels. Whilst multiple key threatening processes have contributed to this decline, the impact of fish losses at water diversions has been largely underestimated and remains unaddressed. There is mounting evidence that significant numbers of fish (ranging from hundreds to millions at individual diversions) are being lost from rivers through water abstraction. Whilst the true extent of the impact across the entire Basin remains uncertain, given the extent of water diversion from most rivers, it is likely that fish entrainment is significant and will need to be addressed if a recovery in native fish populations is to be achieved.

Fish screens can be used to protect fish populations whilst maintaining irrigator entitlements. Although several different screening approaches are currently applied elsewhere in the world, most of which would be suitable for application in the Murray-Darling Basin, it is essential that technologies are designed with the needs of local fish species in mind. In particular, screens will need to meet certain design criteria (e.g. maximum velocities at the screen face, or be made out of suitable material) that ensure fish are excluded from abstracted water and do not suffer injury or mortality. Currently no such criteria or guidelines exist for the design of screens suitable for Australian native fish, and this study has been the first to collect data relevant to the Murray-Darling Basin.

A combination of field and laboratory-based experiments at simulated intake screens was used to test a variety of approach velocities (velocities in front of and perpendicular to the screen face) and screening materials. It was found that the installation of fish screens has great potential to significantly reduce fish entrainment at intakes and, in some cases, mortality at an experimental intake was reduced from over 90 % (unscreened) to less than 2 % (when screened) in the laboratory. Approach velocities (measured 8 cm from the screen) of up to 0.4 m/sec (1.5 m/sec slot velocity through the screen) were effective in reducing entrainment of juvenile golden perch and silver perch in laboratory trials, with very little injury or mortality resulting from incidental screen contacts or impingement. In comparison, field observations of an assemblage of fish at a screen in a river demonstrated that even modest increases in approach velocity (from 0.1 to 0.5 m/sec) produced a significant increase in the rate of

screen contact for fish smaller than 150 mm, with the impact being more marked the smaller fish were.

Based on these findings, it is recommended that approach velocities for Murray-Darling Basin fish screens not exceed 0.1m/sec. Such a guideline reflects acceptable limits in other parts of the world and there are currently many cost effective screening solutions available to achieve this. The recommendation of 0.1 m/sec is precautionary, since until the potential sub-lethal or lethal impacts of the increased rate of screen contact can be understood for a larger range of species and size classes, there is some uncertainty as to whether higher approach velocities will afford protection for the entire assemblage of fish. For some species, velocities exceeding 0.1 m/sec may be appropriate. For instance for perforated plate screen, approach velocities of up to 0.4 m/sec provided adequate protection for juvenile silver perch and golden perch. But if the objective is to devise design criteria that will protect a wide range of species and life history stages from diversion, then criteria need to be set to protect the most vulnerable in the population. Further laboratory testing of small-bodied species and a greater range of early life history stages is needed before deciding whether critical velocity thresholds could be set at higher levels.

Perforated plate is a material commonly used for fish screens elsewhere in the world. It is readily available, cost effective and has reliable long-term performance when combined with appropriate cleaning techniques. Golden perch and silver perch could easily free themselves after contacting a perforated plate screen over a large range of approach velocities, with few injuries recorded. Further, there was little difference in the rate of screen contact or entrainment when using three different sizes of woven wire mesh (5, 10 and 20 mm). Together, these findings suggest that screening material may not be as important a consideration (as approach velocity) when designing screens for the protection of fish.

It is advisable that the recommendation of a maximum approach velocity of 0.1 m/sec be further tested in the laboratory across a larger range of vulnerable species and life history stages, and guidelines regarding screen design criteria allowed to adaptively evolve as new information come to hand. But given the desire to address the significant declines in native fish populations across the Murray-Darling Basin, and based upon the mounting evidence of fish losses at diversions, it is prudent to start putting guidelines in place now, on the basis of the best available science. The recommendations made here provide the first information upon which to begin screening whilst setting hypotheses for further field and lab validation. Such an adaptive management approach to fish screening has worked well for over a century in parts of the United States of America (USA) and has been demonstrated to be hugely successful over the last decade for the refinement of upstream fishway design for native fish in the Murray-Darling Basin. It is not unreasonable to expect that a similar outcome could be achieved within the next decade in the development of fish screens at water diversions in the Basin. However, to achieve this it is important that the right processes be put in place to encourage a systematic approach to screening design, uptake and maintenance.

Successful screening programs in the USA were reviewed and used to determine actions which could be put in place to facilitate large-scale fish screening in the Murray-Darling Basin. Fish screening coordinating committees are a key factor to overseas successes and should be established to provide guidance regarding the setting and refinement of screen design criteria based on the latest science, to identify funding opportunities and to prioritise projects for implementation. Committees need to engage community members, particularly irrigators, to support the program. Government-irrigator cost-share programs have proven to be strong incentives to screen diversions elsewhere in the world and their use should be further explored for the Murray-Darling Basin. Individual Catchment Management Authorities can be involved at a local level by developing diversion management plans. State and federal agencies could support local initiatives through legislative and policy support.

Given that no screen design criteria currently exist for Australian native fish, appropriate guidelines urgently require preparation. Guidelines from other countries can help inform screen material, positioning, maintenance and performance standards. Approach velocity, however, will need to be a

feature of primary consideration when developing new guidelines for the Murray-Darling Basin. It is clear that approach velocities will need to be set to protect vulnerable species and that an ongoing field and laboratory-based research program will be needed to adaptively inform further criteria development. Diversion management plans for all catchments in the Murray-Darling Basin, backed by adaptively implemented guidelines, will provide a robust framework to arrest further native fish declines.

1. GENERAL INTRODUCTION

1.1 Background

Increasing demand for water worldwide is placing enormous pressure on the biodiversity of freshwater ecosystems (Dudgeon *et al.* 2006). River regulation (including impoundment, diversion and abstraction) is widespread, but is most severe in regions with highly variable flow regimes (Vörösmarty *et al.* 2000, Dudgeon *et al.* 2006). Regulation can impact on fish by altering habitats and disrupting flow-dependent life history strategies such as spawning and recruitment (Walker 1985, Humphries and Lake 2000, Humphries *et al.* 2002). Physical removal of fish from rivers through entrainment at water diversions has also been implicated in worldwide species declines (Moyle and Williams 1990, Musick *et al.* 2000). Mechanical injury and death can occur to fish that pass through diversion structures (Baumgartner *et al.* 2009). Many individuals do manage to survive diversion and form viable populations in off-river canals and impoundments (King and O'Connor 2007, Baumgartner *et al.* 2009). But once diverted from the river, it is generally accepted fish are lost from natural river populations (Prince 1923, Baumgartner *et al.* 2009).

The loss of fish at water diversion points can be mitigated without preventing flows being delivered to where they are needed. Throughout the world, fish screens are successfully used to prevent fish being entrained in diverted water (Moyle and Israel 2005). In western drainages of the USA, the impact of unscreened irrigation diversions on migrating salmonids was recognised early last century (Brannon 1929). Initially, fish screening was carried out in a non-systematic, *ad hoc* and largely ineffective way (McMichael *et al.* 2004). Since then, substantial resources have been devoted to research and development of screening technologies and screening programs are now strategically prioritised, well-resourced and backed by an evidence-based approach to the development of physical design criteria (e.g. McMichael *et al.* 2004, Peake 2004, Cech and Mussen 2006, White *et al.* 2007). There is still much uncertainty about the cumulative benefits of large-scale screening programs on the sustainability of fish populations, although it is acknowledged that diversion screening has slowed population declines or even prevented localised extinctions (Moyle and Israel 2005).

In the Murray-Darling Basin (Australia) no fish screening program currently exists. The Basin contains a vast network of water diversion infrastructure (e.g. regulators and pumps) that was built over the last century to service Australia's largest irrigation industry. The volume of flow diverted from the Basin's river systems is substantial and has been estimated at 87% of natural flows (Kingsford 2000). It is generally acknowledged that this level of diversion has had an impact on aquatic ecosystems and contributed to a decline in native fish populations (MDBA 2010). Most of the water diverted from the Basin (95%) is used for irrigation (Crabb 1997). There are several large-scale irrigation schemes and thousands of smaller independent irrigators diverting flows from almost all of the Basin's Rivers. Water diversions for other consumptive uses such as town supply, livestock supply and for environmental flow delivery are small by comparison. While the degree of diversion differs from region to region and time to time, at certain places or times it can be significant. For example, at Berembed Weir the volume of water diverted for irrigation can be as high as 283% greater than the volume flowing downstream to the Murrumbidgee River (Baumgartner *et al.* 2007). Similar scenarios have been documented elsewhere in the Basin, such as at Menindee Weir on the Darling River and Yarrawonga Weir on the Murray River, where volumes of water diverted during peak irrigation times can far exceed downstream flow (Thoms *et al.* 2004, King and O'Connor 2007).

There is mounting concern that fish losses at unscreened diversions in the Basin are contributing to fish population declines (Lintermans and Phillips 2004, King and O'Connor 2007, Baumgartner *et al.* 2009) (see section 4.2 page 38 for more detail). Evidence supporting this assertion arises from several studies documenting that significant numbers of fish can be removed by pumps and regulators (King and O'Connor 2007, Baumgartner *et al.* 2009). The scale of impact will undoubtedly differ between locations based upon local fish populations, time of year and size of diversion (Moyle and Israel 2005, King and O'Connor 2007). But given the sheer volume of water that is diverted across the Basin and

the fact that at times the volumes diverted can significantly exceed that flowing downstream, it is likely that the numbers of fish removed are significant and will need to be reduced if fish population declines are to be addressed. In the Murray-Darling Basin, the size range of fish vulnerable to extraction include small-bodied species and those whose eggs and larvae passively drift downstream in large densities (Humphries *et al.* 2002, Gilligan and Schiller 2003, Lintermans and Phillips 2004) (King and O'Connor 2007, Baumgartner *et al.* 2009). This poses a unique challenge for developing a screening program in the Murray-Darling Basin, as design criteria need to be developed for multiple species and size classes. This is in contrast to programs elsewhere throughout the world where criteria are typically targeted towards downstream migrating smolt of a few salmonid species (NMFS 1997).

1.2 Purpose of this study

There is some information available regarding the species and life history stages of native fish entrained at diversions in the Murray-Darling Basin (King and O'Connor 2007, Baumgartner *et al.* 2009). To date, however, there has been no research into how this entrainment can be mitigated through screening or any other mechanisms. This study represents the first attempt to collect data necessary for the development of screen criteria specifically for Australian native fish. Consideration was given to minimising both the physical entrainment of fish as well as the extent to which fish become impinged on screens (e.g. Zydlewski and Johnson 2002, Peake 2004, Swanson *et al.* 2005a). It is important to ensure that whilst a screen may prevent entrainment at a diversion, fish are not simply impinged on (or held against) the screen, and therefore still being injured or killed. To achieve this we used experimental fish screens in both a riverine (Chapter 2) and laboratory (Chapter 3) setting to determine the relative effect of different approach velocities (flows perpendicular to the screen face) and screen mesh sizes. This approach enabled us to observe how a fish community interacts with a screen in a 'natural' riverine context as well as allowing variables of interest to be manipulated in a controlled setting, thus giving greater capacity to make recommendations regarding physical design criteria.

Given the infancy of research and development of fish screening in the Murray-Darling Basin it is vital that any emerging screening program consider the successes and failures of programs in other parts of the world. In Chapter 4 we critically review the key aspects of long-established fish screening programs in the USA. In this region of the world, the loss of fish at water diversions has been identified as a significant fisheries management challenge for close to a century (Brannon 1929). During this time, screening programs have evolved from being uncoordinated and ineffective to a large-scale, well-resourced industry which is strategically coordinated (McMichael *et al.* 2004). Key features of these programs are presented within the context of how best to develop a fish screening program in the Murray-Darling Basin.

A final discussion which considers results from Australian fish in the context of international screening programs is then used to make recommendation regarding screen design criteria, identify future research and development needs, and outline what considerations and activities need to be undertaken to instigate a fish screening program in the Murray-Darling Basin.

2. OPTIMISING FISH SCREEN DESIGN CRITERIA USING A FIELD-BASED APPROACH: EFFECT OF MESH SIZE AND APPROACH VELOCITY

2.1 Introduction

Lab-based studies are commonly used internationally to develop fish screen design criteria, specifically when seeking to understand species-specific swimming performance when exposed to different velocities (Swanson and Young 1998, Peake 2004), or to quantify behaviour, injury and mortality of fish exposed to different screen conditions (Zydlewski and Johnson 2002, Peake 2004, Swanson *et al.* 2005a, Cech and Mussen 2006). Typically utilising flumes, lab-based studies allow increased control over fish sample sizes and the ability to manipulate and isolate variables of interest, thus improving experimental rigour. Laboratory studies, however, may fail to truly represent natural conditions or provide an accurate representation of fish encountering screens in the wild. Additionally, lab-based studies tend to focus on one or two species and few age classes (e.g. Swanson and Young 1998, Zydlewski and Johnson 2002, Peake 2004). Species and age-specific criteria can be defined using this process, but these studies are less appropriate if the desire is to mitigate impacts across a more diverse assemblage of species. Further advances in fish screen design will be enhanced by using field-based experiments in combination with lab-based studies. This is of particular relevance to the Murray-Darling River System, where a large proportion of the fish community (including large and small-bodied fish and a wide variety of life history stages) is migratory and requires protection at diversion points (Humphries *et al.* 2002, Gilligan and Schiller 2003, Lintermans and Phillips 2004, Barrett *et al.* 2008).

Field-based investigations of fish encountering screens are rare [but see Rose *et al.* (2008) for an exception] usually because high turbidity in many river systems limits opportunities for direct observations (Danley *et al.* 2002). The recent application of dual-frequency identification sonar (DIDSON; Sound Metrics Corp.) to fisheries research has proven to be an effective tool for quantifying fish abundance, size, behaviour and habitat use in dark or turbid waters, where traditional video capture techniques are ineffective (Moursund *et al.* 2003, Tiffan *et al.* 2004, Baumgartner *et al.* 2006). Such technology may provide a powerful tool in studying fish behaviour around diversion screens as it could allow screen impingement rates to be quantified in a more natural environment.

Two important screen design considerations for fish protection are the material a screen is constructed from and water velocity perpendicular to the screen face; often termed approach velocity. The purpose of this chapter is to document the interactive effects of screen presence, mesh size (5, 10 or 20 mm woven galvanised mesh) and approach velocity (0.1 or 0.5 m/sec) on the number of fish entrained at a water diversion in a riverine setting using an experimental pumping station. A fish screen may prevent entrainment, but injury or mortality may still occur if a fish contacts the screen face (Swanson *et al.* 2004). Therefore, directly observing fish behaviour in close proximity to the screen is important for understanding optimal screen design criteria. To achieve this, DIDSON was used to quantify screen contact rates and behaviour around the screen. This study provides the first data for the development of fish screen design criteria for Australian Rivers and, to our knowledge, is the first study to test the effectiveness of a dual-method for investigating the interaction between an open-water fish assemblage at an experiment diversion in a riverine setting.

2.2 Methods

2.2.1. Study area

The Murray-Darling Basin is Australia's largest catchment, covering over one million square kilometres and draining water from five different states and territories. Approximately 10,200 GL of water is diverted per year to service the irrigation industry, equating to 95 % of all water use in the Basin (MDBC 1995, Crabb 1997). The remaining 5 % is used for stock and domestic and inter-Basin transfers. This study was undertaken at four sites, all within 12 km upstream of Narrabri (30.324963°S, 149.786742°E, 215 m elevation) on the Namoi River (New South Wales) (Table 1 and Figure 1). The Namoi River extends 845 km from the Great Dividing Range near Armidale to the Darling River and flow releases are heavily regulated during the irrigation season (between September and April) by two upland storages (Keepit and Split Rock Dams). Land use of the lower Namoi catchment consists predominately of irrigated wheat and cotton, as well as stock grazing. The system is characterised by low topography, deeply-incised channel banks and few instream regulating weirs. Water is therefore usually pumped from the main channel into off-river storages, an approach typical of most rivers in the northern Murray-Darling Basin. Previous research has shown that significant numbers of fish can be entrained by irrigation pumps using this method of water extraction (Baumgartner *et al.* 2009).

Field studies were undertaken at four sites that were suited to using the experimental pumping station. Each site required a gravel bar with excavator access to place the pumping station (Figure 2). The river depth needed to be 2-3 m adjacent to the pump to ensure the screened intake was totally submerged and to permit screen exchanges among treatments. River flow was low at the time of study (0.03 m/sec \pm 0.01 S.D.), therefore the approach velocity created by the experimental screen was the dominant flow vector.

Table 1. Coordinates of the four pumping sites used during the study.

Site Code	NSW Fish Research site number *	Coordinates	
A	3385	-30.35450	149.78752
B	3384	-30.34579	149.78946
C	3387	-30.39496	149.85190
D	3386	-30.39161	149.84660

* All fish catch and water quality data are stored in the NSW DPI Freshwater Fish Research Database

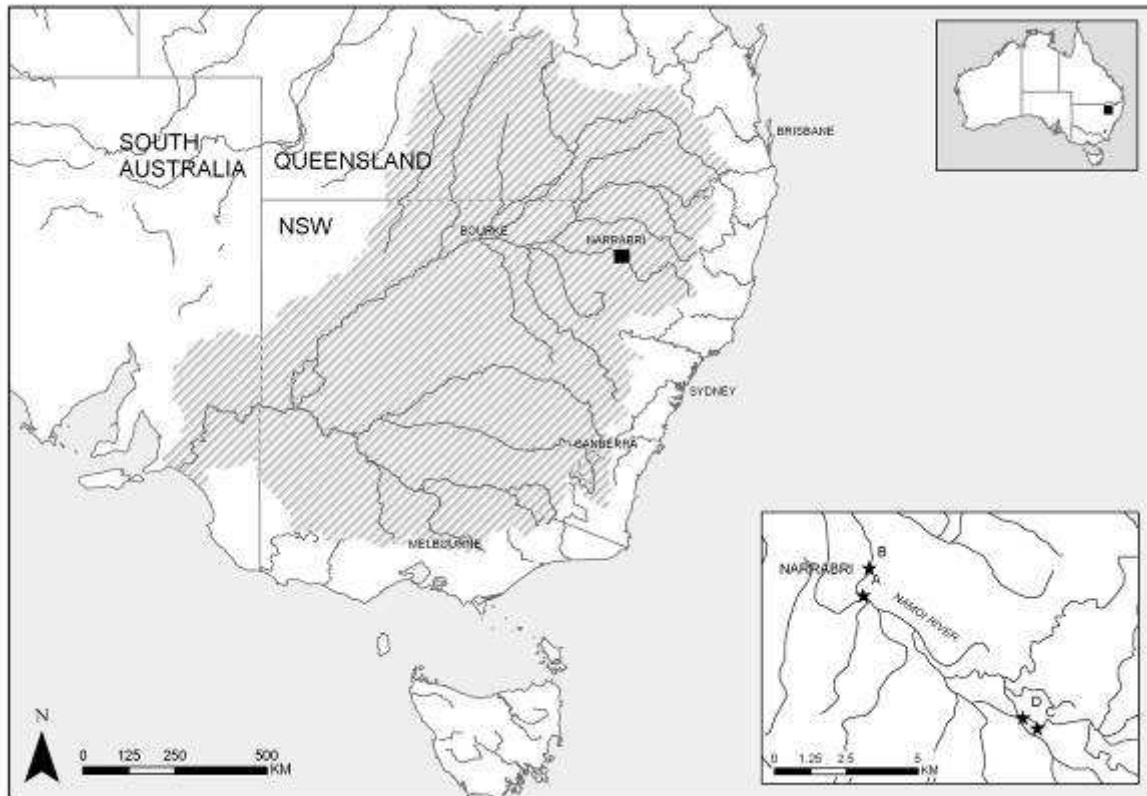

Figure 1. Location of the four study sites on the Namoi River showing the Murray-Darling Basin (grey thatched).



Figure 2. Picture of the experimental pumping station showing typical deployment into water adjacent to a gravel bar.

2.2.2. *Experimental pumping station*

The experimental pumping station consisted of three main components: 1) a pump, 2) an intake pipe fitted with an experimental screen, and 3) a discharge outlet with fish collection nets (Figure 3).

Pump – A diesel-powered, mixed-flow (centrifugal) pump with a gear reduction marine drive was used to deliver water to the experimental facility. When operated at a very low head-differential between the intake and outlet (as in this study) the system was capable of up to 38 ML/day (equating to a velocity of approximately 3 m/sec through the 450 mm (or 18 inch) diameter intake pipe). The discharge created was lower than is typical for pump systems commonly installed in the northern Murray-Darling Basin, where systems are more commonly capable of about 90 ML/day (Colin Barnes, BnB Engineering Narrabri, personal communication). A butterfly valve was used to control flow out of the discharge outlet. Flow rate, pipe velocity and total discharge obtained by the pumping station during each trial were measured with a Flo Pro (series 2) ultrasonic flow meter with a doppler sensor (Mace, Sydney Australia) installed in the intake pipe.

Fish screen – The 10 m long steel intake pipe was fitted with an experimental screen comprising a solid flat bottom and a tapered top (2.4 m diameter and 1.5 m height: Figure 4). The outer surface of the screen incorporated 12 individual vertical panels (1 m high by 0.6 m wide), where screens of varying mesh size (5 mm, 10 mm and 20 mm woven galvanised wire) could be interchanged. Screen surface area could be altered by replacing some mesh panels with solid aluminium blanks, thus closing off a proportion of the total diameter of the experimental screen to flow (Figure 4). To generate the two approach velocities tested in this study, two different open-screen face configurations were used. For the 0.5 m/sec approach velocity, 10 solid panels were used, leaving two mesh panels as the open-screen face (0.36 m² open-screen face, positioned 120-180° relative to the river flow: Figure 5). This position was on the open-water side (farthest from the bank) and pointing slightly downstream to maximise the possibility of encountering fish as they moved upstream. For the 0.1 m/sec approach velocity, eight solid panels were used, leaving four panels as the open-screen face (0.72 m² open-screen face, positioned 0-60° and 120-180° relative to the river flow: Figure 5). This created a larger surface area of screen that allowed the lower approach velocity to be generated. Separating the open-screen area with two solid panels allowed the four open-screen faces to be observed with two sonar units without any overlap in the viewing window of each (see below).

Discharge and fish collection – Diverted water was discharged back to the river downstream of the intake through a 40 m long, 480 mm (19 inch) heavy-duty vinyl ‘layflat’ irrigation hose (Figure 2). A settling tank was fitted to the end of the hose to reduce flow velocity and bed erosion, before the water was subsequently discharged into two fyke nets (6 mm stretch mesh, 10 m long, with two internal funnels). The nets were long enough to ensure that velocities had dissipated sufficiently to minimise injury to collected fish.

2.2.3. *Fish community surveys*

To establish species composition and relative abundance at each site, standardised electrofishing and seine netting surveys were conducted at the site after all pumping was concluded. Electrofishing was done with a five metre, twin-hulled aluminium boat mounted with a Smith-Root 7.5 GPP electrofishing unit using a pulsed (120 pulses per second) direct electrical current (DC). A total of 1080 electrofishing seconds (on time) was typically performed at each site with total fishing effort divided into 12 sub-samples (or shots) and undertaken across all available habitat. Fish were dip-netted from the water and placed in a live-well to recover until measured and returned alive to the water after each shot. Any fish positively identified but not dip-netted were also recorded. Electrofishing at each site was supplemented with three seine net samples (6 mm stretch mesh, 1 m drop, 10 m long). The net was deployed in a U-shape and pursed onto the shore. Fish were then counted, measured and released.

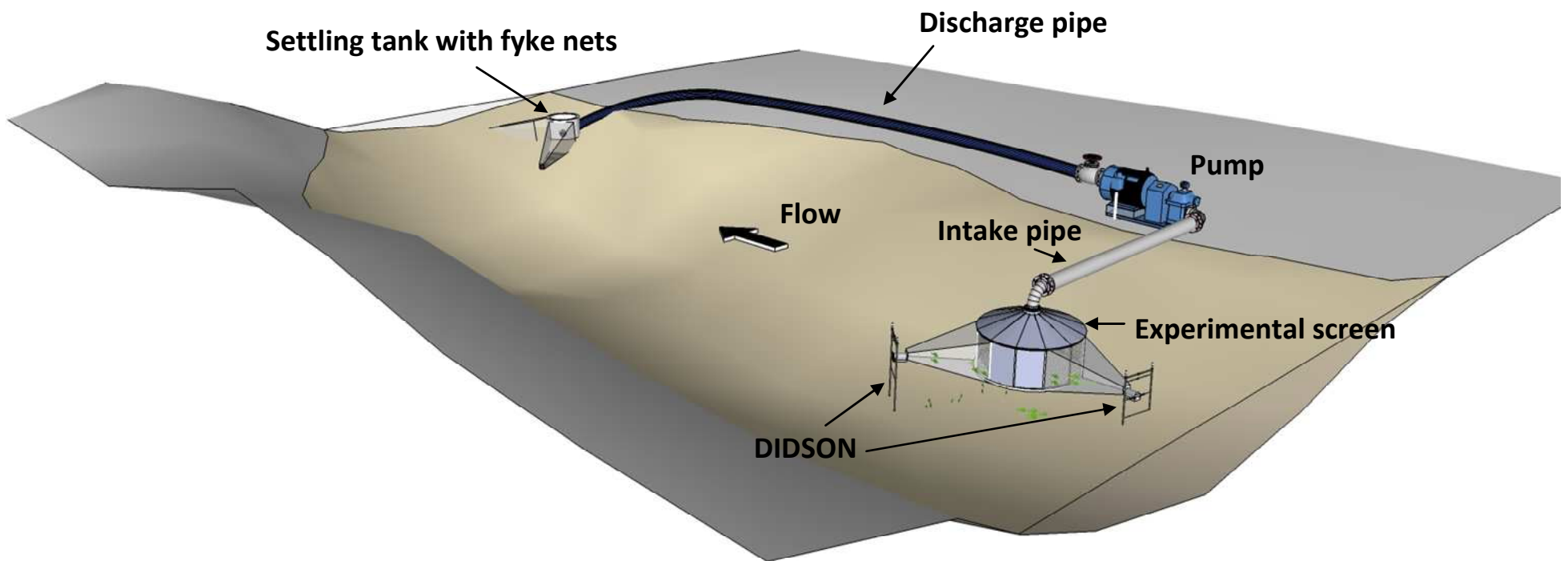

Figure 3. Schematic representation of the experimental pumping station used in the Namoi River showing major components. The experimental screen was cylindrical and comprised a series of removable panels to adjust approach velocity and mesh size. Fish that were entrained into the system travelled through the intake pipe, through the pump, along the lay-flat discharge pipe and were collected in fyke nets retrofitted to a settling tank. Fish behaviour in front of the screen face was quantified using DIDSON.

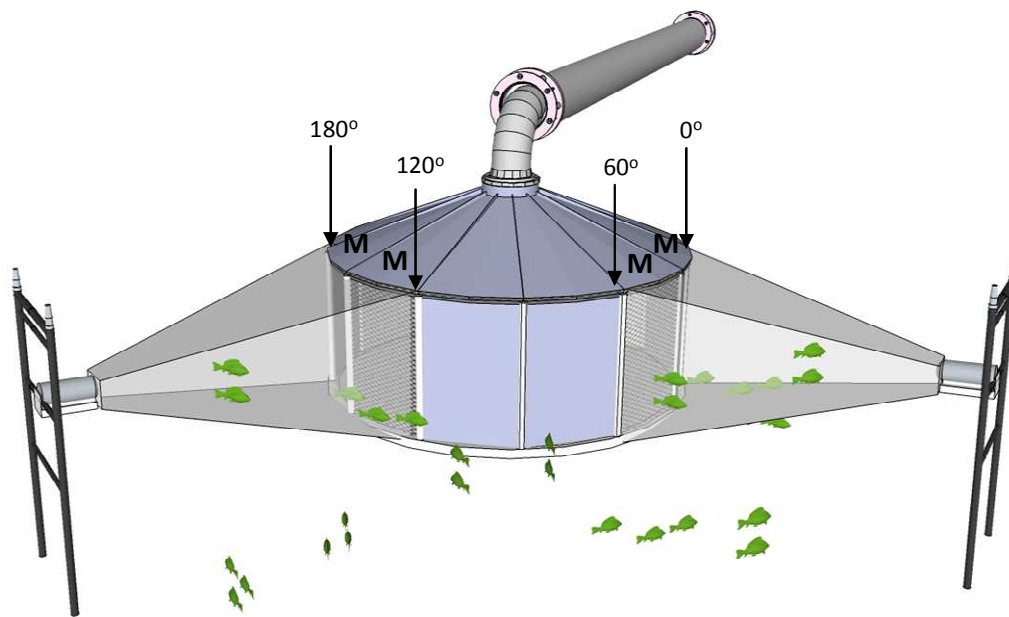

Figure 4. Experimental fish screen showing removable mesh screen panels. These could be removed and replaced with panels of different mesh size. Some were replaced with aluminium blanks to manipulate approach velocity.

Table 2. Tabular representation of the two Latin square experimental designs showing the allocation of mesh treatments within replicate runs for each of two approach velocities.

0.5 m/sec		Treatment mesh (mm)			
Site	A	5	20	0	10
	B	20	10	5	0
	C	10	0	20	5
	D	0	5	10	20
0.1 m/sec		Treatment mesh (mm)			
Site	A	20	10	5	0
	B	10	0	20	5
	C	0	5	10	20
	D	5	20	0	10

a) 0.1 m/sec



b) 0.5 m/sec

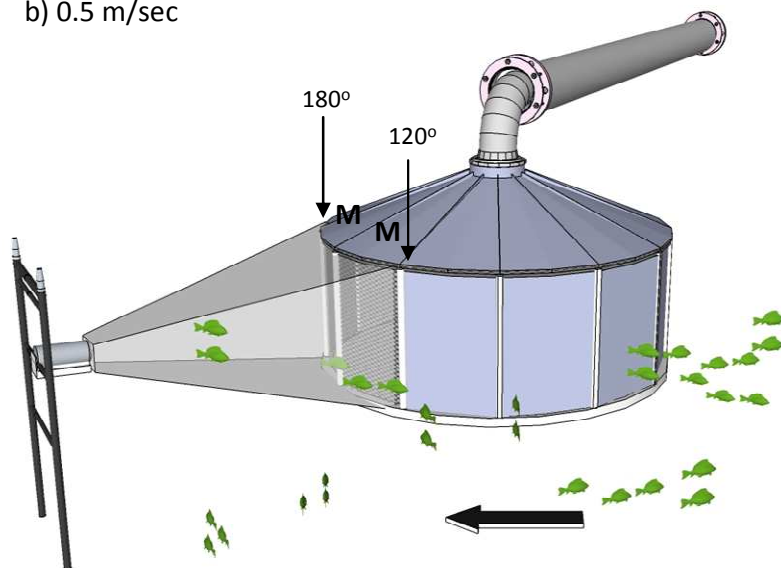

Figure 5. Diagram of the experimental fish screen showing position of mesh screen panels (M) and position of DIDSON for the a) 0.1 m/sec approach velocity, b) 0.5 m/sec approach velocity. Degrees are relative to 0° facing directly into downstream flow (indicated by the arrow). Note the position of blank panels (those not marked with M). To achieve the maximum velocity of 0.5 m.s⁻¹ all panels except two needed to be fitted with blanks.

2.2.4. *Quantifying entrainment*

All fish collected in fyke nets following pump entrainment were measured to the nearest millimetre (fork length for fork-tailed species and total length for rounded-tail species) and counted at the completion of the 4 hour experimental period. The effect of mesh size on catch per unit effort (CPUE: total catch / total flow) was tested with a Latin square (Table 2) ANOVA within each velocity, after partitioning out the effects of location and order of treatment. To determine whether there were differences in CPUE between the different velocities a factorial ANOVA was used on the Latin square data, testing the factors velocity, velocity*mesh, mesh, order of treatment, and location.

2.2.5. *Quantifying screen contact*

Acoustic image acquisition - Dual-frequency identification sonar (DIDSON; Sound Metrics Corp.) was used to quantify the number and nature of fish interactions with the experimental screen. The DIDSON was operated in high frequency mode (1.8 MHz), which generates near-video quality images over small distances (<12 m) (Moursund *et al.* 2003). DIDSON uses 96 beams to generate a total field of view of 29° horizontal by 14° vertical under high frequencies (Boswell *et al.* 2008). The DIDSON was horizontally mounted approximately 4 m from the screen face and 1 m below the water surface. The field of view allowed for a maximum of two screen panels to be observed by a single unit. Therefore one DIDSON was required for the higher velocity treatment and two DIDSONs were simultaneously used for the lower velocity treatment when four panels of screen were required (Figure 5). DIDSON units were not synchronised (Belcher *et al.* 1999), which resulted in some acoustic feedback and loss of picture quality. The configuration however, did give acoustic images of adequate resolution to allow an observer to classify data on the basis of fish size and behaviour, but not species.

Post-processing and data analysis - Echograms of each DIDSON sample were captured using Sound Metrics topside software (Sound Metrics 2009). To expedite analysis, sub-sampling of each echogram was performed where the first 20 minutes of footage was discarded to account for any fish behavioural responses to pump start-up. A random start point was then selected in the next 10 minute interval and one minute of footage (600 frames) was extracted at each subsequent 10 minute interval (resulting in 22 one minute sub-samples for viewing).

Post-processing modules were developed in Echoview (Myriax Software: Higginbottom *et al.* 2008) and run simultaneously with the original echogram to assist in target identification, size measurements and to classify movements in relation to the approach velocity (Figure 6). Firstly a background subtraction and target identification module was developed. To assist in recognising fish from debris and static objects (non-moving objects such as substrate and screen) were removed from the echogram and only moving targets greater than 3 mm long were identified. Three millimetres was used as a maximum to minimise the risk of filtering actual fish. The second module developed was for fish tracking to log positional data within the echogram and assist with target recognition and directionality. Analysing data in this way allowed determination of whether fish were approaching the screen or moving away from it.

A target area 0.5 m radius from the centre of each of the 2 panels was drawn on the echogram viewing window and only fish that entered this target area were deemed to have approached the screen. It is important to note that we refrain from using the term 'impingement' in this study and instead refer to screen contact. Impingement is typically used to refer to a prolonged screen contact. The DIDSON was limited in its ability to discriminate a prolonged impingement from a contact. The screen, being a metal object, generates strong acoustic reflections which could not be sufficiently eliminated using background subtraction methods. Targets therefore became virtually invisible once touching the screen so the actual duration of contact could not be accurately determined. For the purposes of this study we therefore refer to any screen interactions as contact, rather than impingement.

To assess contact probability, fish entering the field of view were measured (using a tool within Echoview) and then assigned to one of three behavioural categories:

1. Contact – the fish entered the target area, took a path towards the screen and disappeared upon reaching it;
2. Non-contact – the fish entered and then left the target area without touching the screen; or
3. Not defined – the fish entered the target area although disappeared before either touching the screen or leaving the target area again.

It was deemed important to determine the swimming behaviour of individual fish in front of the screen as it provided some insight as to whether a certain size class of fish was attempting (but unable) to avoid contact due to excessive velocity. Rheotactic alignment in relation to the approach velocity vector was subsequently quantified for all fish in the field of view.

Individual fish were assigned to one of the following five categories:

1. Positive rheotaxis – the fish turned to face away from the screen swimming into the oncoming current;
2. Negative rheotaxis – the fish moved head first towards the screen, or in the direction of the current;
3. Broadside rheotaxis – the fish moved laterally (across) the current;
4. Random – a combination of one or more rheotactic behaviours; or
5. Not Defined – no rheotactic alignment could be confidently defined.

Statistical analyses – The number of fish exposed to each treatment was analysed as probability of contact (proportion of observed fish that contacted the screen). A log-linear model was therefore used to compare the overall probability of contact between the 0.1 and 0.5 m/sec velocities. Further, within each velocity treatment, a logistic model was fitted to the Latin square design to compare the contact probability between mesh types after partitioning out the differences between sites and treatment order. Follow-up analysis compared the parameter estimates and odds ratios for each mesh size with those of the ‘no mesh’ treatment (see Table 3).

To investigate whether the probability of contact was associated with fish length or rheotactic behaviour, a logistic model was used that added length of fish (mm), rheotactic alignment and potential interactions as covariates to the Latin square variables ‘mesh size’, ‘location’ and ‘order of treatment’. Differences in the probability of contact between non-random and random rheotaxis was compared using the profile likelihood confidence intervals of the odds ratios. The predicted probability of contact was plotted for fish of 0 - 300 mm length in each rheotactic category at each velocity.

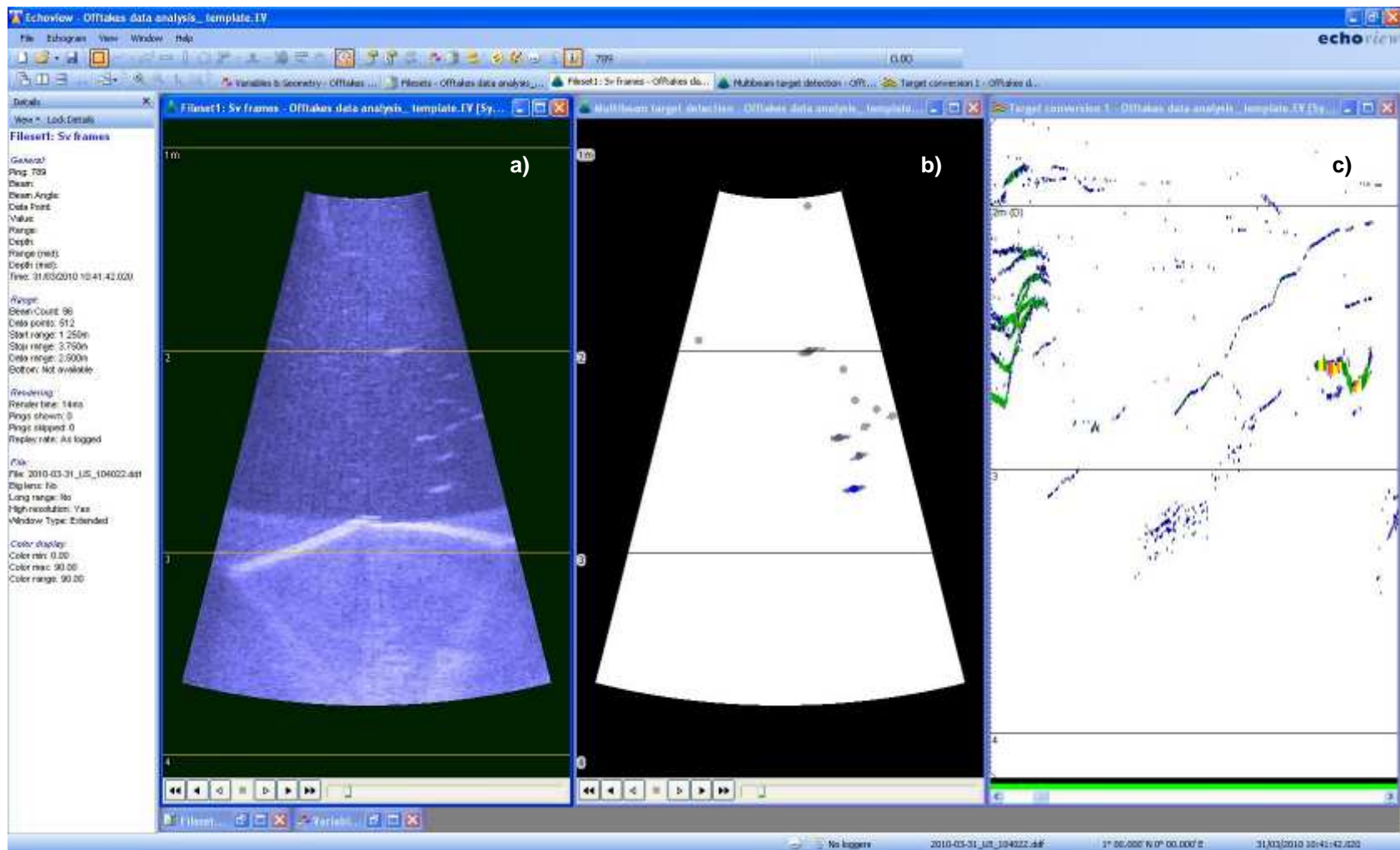

Figure 6. Screenshot showing acoustic echogram obtained from the DIDSON (a) alongside post-processing modules created in Echoview, including a background reduction and target identification module (b) and fish tracking module (c). Screen panels can be seen as light coloured bands at the image bottom.

2.3 Results

2.3.1. Fish entrainment

Twelve fish species were collected using seine netting and electrofishing across all pumping sites during the experiment, but only five species were entrained into the experimental pump system (Table 4). Carp gudgeon were the most abundantly entrained ($n = 138$), followed by Australian smelt ($n = 29$). Spangled perch ($n = 8$), bony herring ($n = 2$) and Mosquitofish ($n = 1$) were occasionally entrained in low abundances. Although a large size range of fish was sampled at the pumping sites, the catches were dominated by small-bodied fish (<60 mm) and it was this size class that was most susceptible to entrainment by the pump (Figure 7).

There was no effect of mesh size on CPUE at 0.1 m/sec ($F = 2.00$, $df = 3, 6$, $p = 0.21$) or 0.5 m/sec ($F = 1.29$, $df = 3, 6$, $p = 0.36$) (Figure 8). Significantly more fish were entrained at 0.5 m/s than at 0.1 m/sec (Figure 8) ($F = 12.90$, $df = 1, 16$, $p < 0.005$). Higher numbers of carp gudgeon, Australian smelt and spangled perch were entrained at increased approach velocities (Table 4). There were no significant interactive effects between velocity and mesh size on CPUE of fish entrained into the experimental pumping facility ($F = 0.60$, $df = 3, 16$, $p = 0.63$).

2.3.2. Screen contact

Despite the low entrainment rates, DIDSON showed that 6,440 fish approached the experimental screen during the study. Fish were significantly more likely to contact the experimental screen at 0.5 m/sec than at 0.1 m/sec velocity (Likelihood ratio $\chi^2 = 80.49$, $df = 1$, $p < 0.0001$). At 0.5 m/sec 143 of the 436 (33%) fish observed contacted the screen compared to 259 of the 1902 (14 %) fish observed at 0.1 m/sec. There was no difference in screen contact probability among the different mesh treatments at 0.5 m/sec ($\chi^2 = 4.7$, $df = 3$, $p = 0.198$), but there was at 0.1 m/sec ($\chi^2 = 15.8$, $df = 3$, $p < 0.005$). At 0.1 m/sec fish approaching the 5mm mesh were 71% more likely to make contact than in the 'no mesh' control (Table 3). No significant difference was detected between the 'no mesh' control and 10 mm and 20 mm meshes (Table 3).

The size range of fish contacting the screen was significantly smaller than for those that avoided contact (Figure 9). Furthermore, the probability of screen contact increased with decreasing fish length (Figure 10). Fish below 150 mm were more likely to contact the screen as approach velocity increased from 0.1 to 0.5 m/sec. Fish smaller than 50 mm, had a 40 to 75 % chance of contacting the screen when approach velocities were 0.5 m/s, compared to 15 to 30 % at 0.1 m/sec. Rheotactic behaviour was significantly associated with the likelihood of screen contact at 0.1 m/sec ($\chi^2 = 226.7$, $df = 3$, $p < 0.0001$) and 0.5 m/sec ($\chi^2 = 48.1$, $df = 3$, $p < 0.0001$) (Figure 10). At both high and low approach velocities fish displaying negative rheotaxis (moving head-first towards the screen) were much more likely to contact the screen than those displaying positive rheotaxis (actively swimming away from the screen and against the approach velocity) (Figure 10 and Table 3). Negatively orientated fish were 19 times more likely to be impinged at 0.1 m/s and 8 times more likely at 0.5 m/s (Table 5). Positive aligned fish were significantly less likely to make contact (14 times less likely at 0.1 and 33 times less likely at 0.5 m/s). Fish displaying broadside rheotaxis were four times more likely to make contact than those showing random orientation at 0.1 m/sec, but not different to random fish at 0.5 m/s (Table 5).

Table 3. Odds ratios for probability of screen contact for different mesh sizes when compared to the no mesh treatment at 0.1 m/sec.

Mesh size comparison with the no screen treatment	Odds Ratio*	Confidence interval	Significance
5 mm	1.71	1.1 - 2.8	< 0.05
10 mm	0.62	0.4 - 1.1	ns
20 mm	1.36	0.8 - 2.2	ns

*The odds ratio is the increase or decrease in the probability of contact when compared to the 'no mesh' treatment. For example, at 10 mm mesh size the probability of screen contact is 1:0.62 = 62% less likely than the 'no mesh' treatment, however this was non-significantly (ns) different than a 1:1 ratio at the $p = 0.05$ level.

Table 4. Number of fish entrained within the experimental pump system. Catches are pooled within each velocity and mesh combination. The electrofishing/seine column demonstrates the composition and relative abundance of fish captured at all the experimental site using electrofishing and seine netting.

Common name	Scientific name	Electrofishing / Seine	Entrained by pump										Total catch pump			
			0.1m/s					0.5m/s								
			no mesh	5mm	10mm	20mm	total	no mesh	5mm	10mm	20mm	total				
Goldfish	<i>Carassius auratus</i>	5	0	0	0	0	0	0	0	0	0	0	0	0	0	0
Unspecked hardyhead	<i>Craterocephalus stercusmuscarum</i>	8	0	0	0	0	0	0	0	0	0	0	0	0	0	0
Carp	<i>Cyprinus carpio</i>	102	0	0	0	0	0	0	0	0	0	0	0	0	0	0
Mosquitofish	<i>Gambusia holbrooki</i>	28	0	0	0	0	0	0	0	1	0	0	0	1	1	1
Carp gudgeon	<i>Hypseleotris</i> spp.	200	7	0	7	1	15	38	38	11	36	123	138	138	138	138
Spangled perch	<i>Leiopotherapon unicolor</i>	24	0	0	0	0	0	5	0	2	1	8	8	8	8	8
Golden Perch	<i>Macquaria ambigua</i>	26	0	0	0	0	0	0	0	0	0	0	0	0	0	0
Murray cod	<i>Maccullochella peelii</i>	45	0	0	0	0	0	0	0	0	0	0	0	0	0	0
Murray-Darling rainbowfish	<i>Melanotaenia fluviatilis</i>	92	0	0	0	0	0	0	0	0	0	0	0	0	0	0
Bony herring	<i>Nematalosa erebi</i>	268	2	0	0	0	2	0	0	0	0	0	0	0	0	2
Australian smelt	<i>Retropinna semoni</i>	37	1	0	0	0	1	2	2	14	10	28	29	29	29	29
Freshwater catfish	<i>Tandanus tandanus</i>	2	0	0	0	0	0	0	0	0	0	0	0	0	0	0
Total		837	10	0	7	1	18	45	41	27	47	160	178	178	178	178

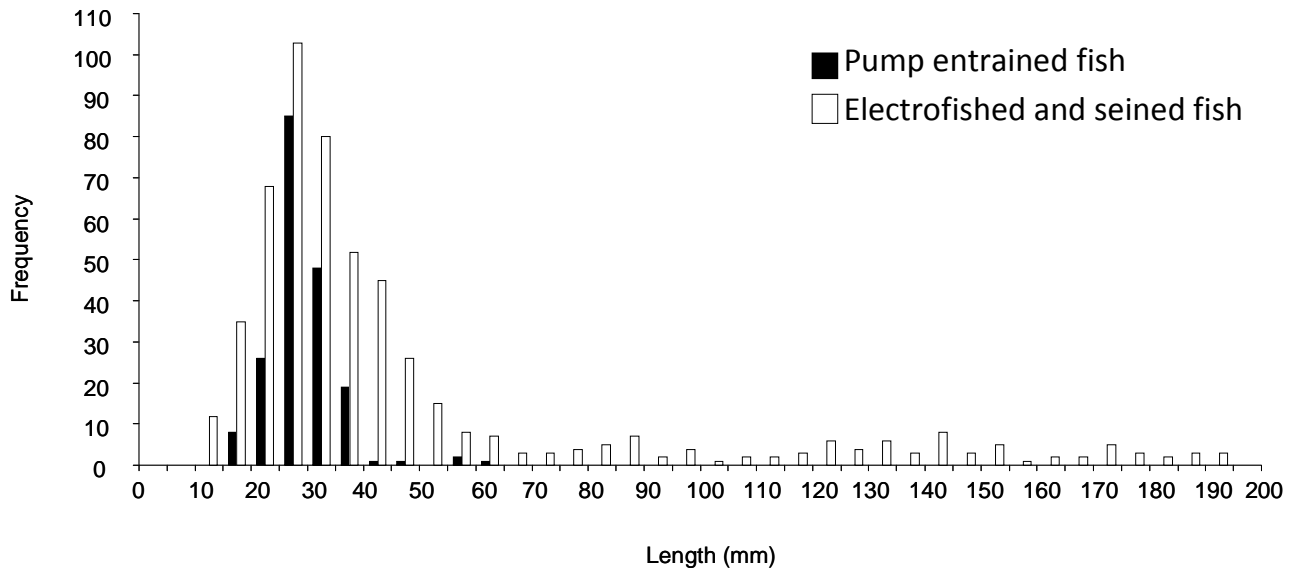

Figure 7. Length frequency histograms for fish sampled at pumping sites by electrofishing and seine netting, and those collected after being entrained by the pump (all treatments pooled).

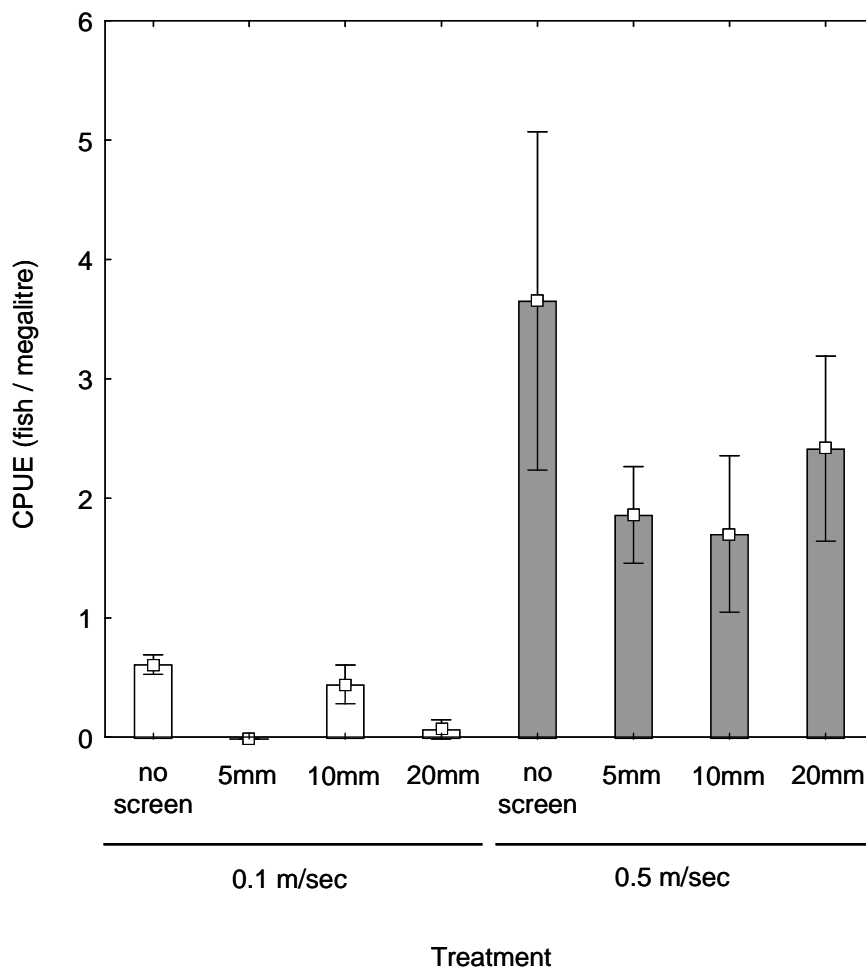

Figure 8. Mean (\pm S.E.) Cath per unit effort (CPUE) of fish across different mesh and velocity treatments.

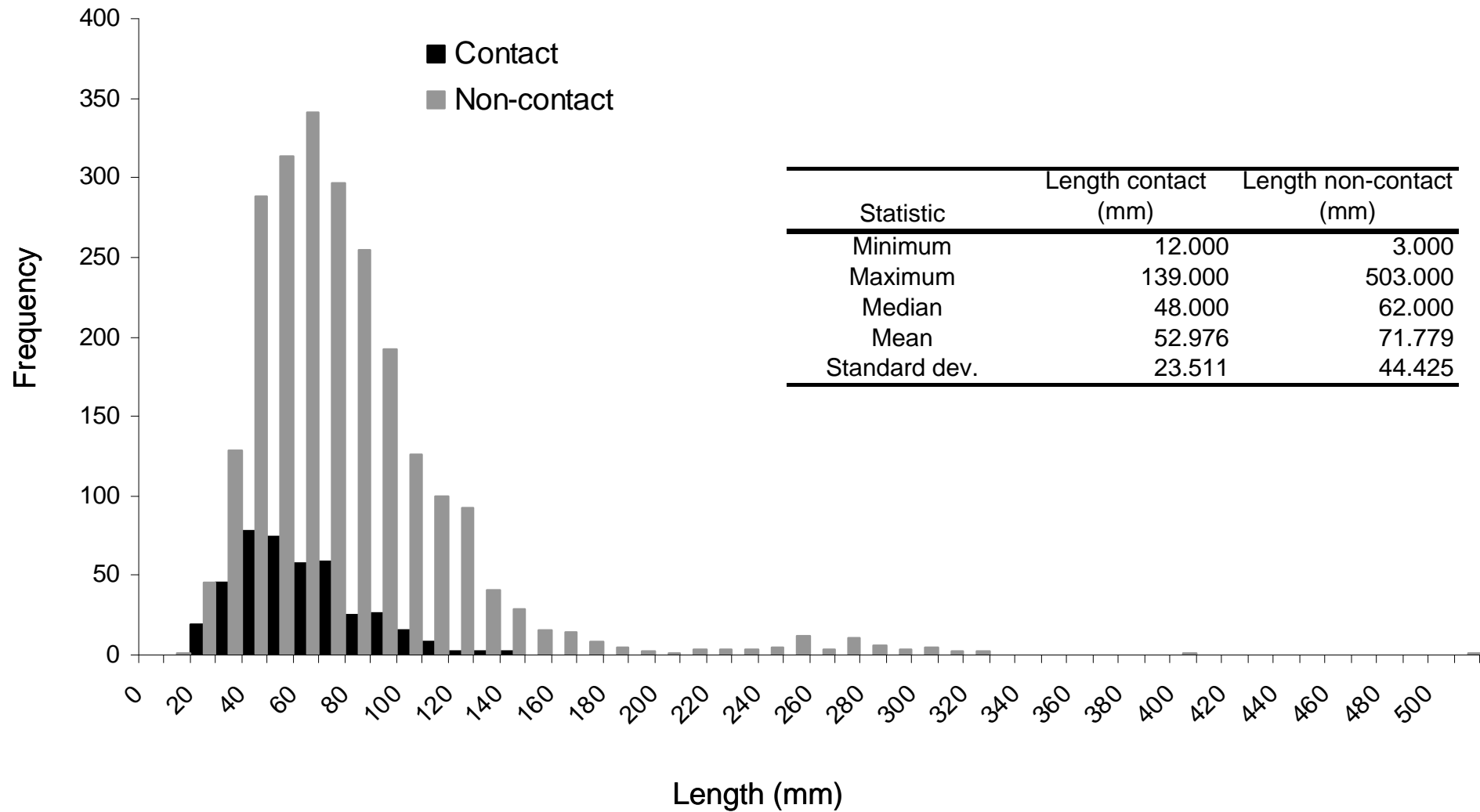

Figure 9. Length frequency histogram showing the size range of fish observed by DIDSON to make contact or avoid contact with the experimental screen

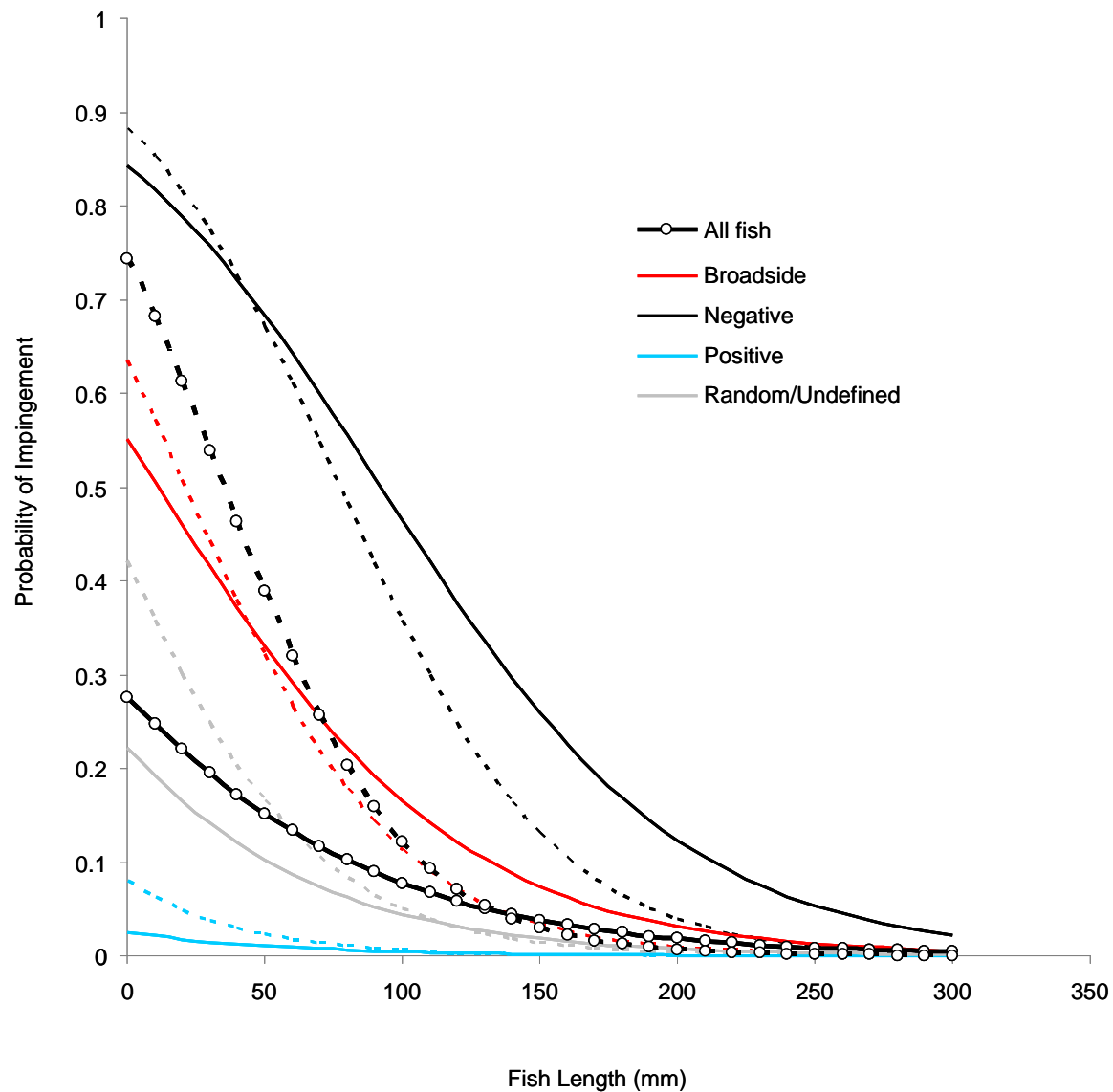

Figure 10. Predicted relationship of probability of screen contact with length and rheotaxis of fish. Solid lines are at 0.1 m/sec and broken lines are at 0.5 m/sec

Table 5. Odds Ratios of rheotactic categories compared to random orientation.

Rheotaxis	0.1 m/sec		0.5 m/sec	
	Odds Ratio*	Comparison to random†	Odds Ratio*	Comparison to random†
Broadside	4.23	sig	1.22	ns
Negative	18.9	sig	7.81	sig
Positive	0.07	sig	0.03	sig

*The odds ratio is the increase in the probability of contact when compared to random orientation. For example, fish showing positive rheotaxis at the 0.1 m/s velocity are $14 \times$ less likely to make contact ($1 \div 0.07 = 14$).

† Significant (sig) or non-significant (ns) at the $p = 0.05$ level.

2.4 Discussion

2.4.1. Optimising screen design for the Murray-Darling Basin

Using a field-based approach to identify fish responses to screen construction successfully determined probability of contact and entrainment and will help develop recommendations to mitigate the impact of irrigation diversions on fish populations in the Murray-Darling Basin. Quantifying responses to different approach velocities helped to determine the risk of contact and entrainment for fish of different size classes. Higher velocities increased both the risk of contact and entrainment which was further influenced by overall fish size, with smaller fish substantially more susceptible to both contact and entrainment. Although approach velocities specified for the protection of fish differ throughout the world, the ranges tested in our study matched those adopted elsewhere. For instance, approach velocities prescribed for the protection of juvenile anadromous salmonids in rivers range from 0.1 m/sec (0.33 f/sec) for fry (< 60 mm length) to 0.2 m/sec (0.8 f/sec) for fingerlings (> 60 mm) (NMFS 1997). Approach velocities of 0.15 m/sec are seen as acceptable for juvenile northern pike *Esox lucius* (Peake 2004) which are weaker swimmers than salmonids (Jones *et al.* 1974). Our results determined that multiple species and size classes were susceptible to entrainment and screen contact and should be considered when developing generic criteria for screening programs in the Murray-Darling Basin.

Although many fish encountered the experimental screen in the current study, not all were susceptible to contact or entrainment. Lower approach velocities further improved the ability for most fish to avoid contact and entrainment. Smaller fish (< 150 mm) were most vulnerable to screen contact and swimming behaviour appeared associated with likelihood of contact. Taken together, these findings indicate that the ability of a fish to avoid contact with a screen is associated with its size and swimming ability, as well as behavioural response when exposed to an approach velocity. Lab-based studies of other species at simulated fish screens report similar findings, with there being a positive relationship between fish size and its ability to avoid contact or impingement (prolonged contact) (Peake 2004) and a positive relationship between contact rate and approach velocity (Danley *et al.* 2002). When encountering an approach velocity in front of a screen fish typically respond by swimming into the current (positive rheotaxis), with swimming speeds increasing with velocity (Danley *et al.* 2002, Swanson *et al.* 2004). There are likely to be critical thresholds where the approach velocity will exceed the ability for a fish to effectively hold its position which is the point of contact for most species (Swanson *et al.* 2004).

The current findings suggest that lower approach velocities are required to protect weaker swimming species, and fish less than 150 mm were most vulnerable to screen contact at the higher approach velocity. A limitation of using DIDSON to determine contact probability was the difficulty associated with determining the duration of contact, distinguishing multiple contacts versus single contacts or lethal and sub-lethal effects. Contact or impingement may increase stress and injury (Young *et al.* 2010), but this may not be sufficient to influence survival (Danley *et al.* 2002, Peake 2004, Swanson *et al.* 2004, Rose *et al.* 2008). The maximum velocity tested here (0.5 m/sec) appeared sufficient to protect fish against entrainment. However, contact rates were significantly higher at 0.5 than at 0.1 for small fish. Until the lethal and sub-lethal effects of these contacts are better understood it is recommended that approach velocities not exceed 0.1 m/sec, to ensure much lower contact rates for smaller fish including juveniles and small-bodied species. These criteria could be better informed by further research into the survival of larval and juvenile golden perch, Murray cod, trout cod and silver perch at fish screens given that these fish are particularly vulnerable to entrainment (Gilligan and Schiller 2003, King and O'Connor 2007, Baumgartner *et al.* 2009) and will undoubtedly be more susceptible to physical injury than larger fish.

Unscreened diversions in the Murray-Darling Basin have high fish entrainment rates (Baumgartner *et al.* 2009). Determining the optimal fish screen mesh size was assumed *a priori* to be important when mitigating potential impacts on fish. Mesh size, however, had little influence on entrainment rates using a woven mesh design at both high and low approach velocities. Screen construction material is therefore likely to be less important for reducing entrainment than optimising approach velocity.

Comparisons of entrainment and survival rate of bull trout *Salvelinus confluentus* fry exposed to different screen materials support this assertion (Zydlewski and Johnson 2002). In that study, little difference in survival and entrainment rates were found between vertical profile bar, perforated plate, horizontal profile bar and woven-wire screen. If velocity is optimised, the type of screening material used becomes less of a consideration. The critical issues are then developing a screen design which optimises approach velocity whilst minimising debris accumulation and flow restriction. Identifying a solution which satisfies all three of these criteria will ensure solutions are fish-friendly, require little maintenance and satisfy irrigation delivery needs.

2.4.2. Effectiveness of the dual approach for field evaluations

The dual method of directly quantifying entrainment and contact using netting and DIDSON had certain advantages. DIDSON provided information on behaviour around screens which could not be gathered by netting alone. It is clear that the low entrainment rates determined by net catches were not due to the absence of fish around the experimental screen, because many fish were observed to approach the screen face. Although the majority of fish managed to avoid entrainment, many still made contact with the screen. These contacts may need to be minimised to ensure the protection of smaller fish (Young *et al.* 2010).

Some limitations with the way that the DIDSON was deployed should be resolved for future studies. Aspect is a known limitation of DIDSON technology. Images captured by the sonar are typically recorded in 2-dimensions which can limit the ability to track target positions accurately. It was therefore difficult to determine whether a fish swimming towards the water surface contacted the screen face, was impinged for a prolonged period, was entrained, or avoided contact all together by moving over the top of the screen. It is therefore possible that DIDSON footage may have resulted in the over estimation of contact rate and fish impact. However, experiments on golden perch exposed to equivalent approach velocities in a laboratory flume were found to produce slightly higher estimates of contact probability than determined in the current study using the DIDSON for an equivalent size range of fish (40 – 50 mm) (see Chapter 3). This provides added confidence that, in spite of the limitations mentioned, field estimates using DIDSON have great potential for field verification of laboratory studies.

A common field-related constraint is the inability to control sample sizes of fish among treatments. The number of fish approaching the screen varied among sites and days (identified by both the DIDSON and electrofishing and seine netting) and reduced the statistical power needed to reliably detect differences. This is a problem specific to field-based studies and can be overcome to some degree by increasing sampling effort and the level of replication, although project budgets do not always allow for this (Downes *et al.* 2002). The optimisation of fish screen criteria in the Murray-Darling Basin will need to be an ongoing activity, with criteria refined as more data become available. Based on the strengths and limitations of the field approach used here, it would make sense that a combination of laboratory studies with some degree of field validation be undertaken when developing screen design criteria. For field validation, we have demonstrated that a dual method using netting and DIDSON would be preferable to netting alone.

2.4.3. Conclusion

No screening criteria exist for Australian freshwater fishes and this study has provided the first results from which to begin optimising screen design to mitigate the impact of irrigation diversions on fish populations in the Murray-Darling Basin. The results indicate that the design of fish screens in the Murray-Darling Basin should aim at minimising entrainment and screen contact by optimising approach velocities. The results indicate that vertical panel screens generating velocities up to 0.5 m/sec have great potential for reducing the entrainment of a wide range of species and size ranges of fish in the Murray-Darling Basin. Small fish had a higher probability of contacting the screen face at 0.5 m/sec than 0.1 m/sec. Until the severity and potential sub-lethal and lethal effects of contacts is better understood for Murray-Darling Basin fish species, it is recommended that a precautionary

approach velocity of 0.1 m/sec be applied where juvenile and small-bodied fish require protection. Such an approach velocity is in line with the accepted standard for the protection of fish fry in other parts of the world (e.g. NMFS 1997, Peake 2004). If approach velocity can be optimised, it would appear from this study that the aperture size of screen mesh is a less important consideration for fish protection.

3. EFFECT OF VELOCITY AND LIGHT ON THE ENTRAINMENT AND IMPINGEMENT OF JUVENILE GOLDEN PERCH AND SILVER PERCH AT A SIMULATED INTAKE SCREEN

3.1 Introduction

Intake screens intended to prevent the entrainment of fish at water intakes can result in injury and mortality if fish contact, or become impinged (prolonged contact), on the screen face (Swanson and Young 1998). Typically, screen design criteria aimed at reducing these interactions have been developed using laboratory studies of fish swimming capabilities at experimental screens, with the majority of studies quantifying impingement, survival and injury during exposure to varying velocities (Peake 2004, Swanson *et al.* 2005a, White *et al.* 2007) and screen materials (Zydlewski and Johnson 2002). Although laboratory assessments do not observe fish behaviour under natural conditions, they do permit greater control over treatment groups, can be standardised over a large number of replicates and therefore produce greater precision than field-based trials (Danley *et al.* 2002). Preliminary laboratory investigations may therefore provide useful data upon which to base screen design criteria for later field verification.

There has been some contention regarding the utility of some laboratory measurements of swimming performance when evaluating intake screens, primarily surrounding the type of velocity vector that is generated (Swanson and Young 1998, Peake 2004). Velocities perpendicular to a screen rapidly decrease with increasing distance from the screen-face, and as such, screen design guidelines typically refer to approach velocity (see page xi), being the velocity at a specified distance from the screen (8 cm or 3 inches is common; NMFS 1997). Decreasing velocities mean that to avoid contact or impingement, a fish need only engage in fast-start or burst swimming activity over a short distance (Peake 2004). Peake (2004) demonstrated that northern pike *Esox lucius* exposed to velocities that declined with distance to an intake screen were able to avoid impingement under higher approach velocities than predicted by swim tunnel experiments with constant and uniform flow. But in other studies impingement has been shown to occur at approach velocities significantly lower than a fish's swimming capability (Swanson and Young 1998). These studies identify the problem associated with using constant velocity fields and measurements of prolonged swimming performance when evaluating intake screens.

Populations of Murray-Darling Basin fish species have suffered significant declines over the past 50 years and a study of silver perch and golden perch passing through Euston Weir on the Murray River revealed a 95 % and 50 % decline in respective numbers between 1940 and 1990 (Mallen-Cooper and Brand 2007). Populations have declined due to a number of factors, including habitat degradation, river regulation and the presence of barriers to passage (Lintermans 2007). The presence of both species in irrigation canals and off-stream storages suggests that entrainment at water diversions is also contributing to losses (King and O'Connor 2007, Baumgartner *et al.* 2009). Both species are officially listed as either vulnerable or endangered in certain States of Australia and are of significant cultural and recreational angling importance. There is presently limited capacity to effectively address the loss of these species and associated mortality and injury within the Murray-Darling Basin at un-screened diversions (King and O'Connor 2007, Baumgartner *et al.* 2009). In the absence of any existing screening guideline, it is desirable to develop some as a matter of urgency, and preferably this needs to be based on experimental data. Swimming information presently exists for sub-adult Australian species and this has been used to refine fishway design (Mallen-Cooper 1992, 1994).

However, such information is concerned with prolonged swimming performance and a different approach is needed to develop design criteria for intake screens.

In this study we used an experimental screen and flume which generated velocities which declined significantly with increasing distance from the screen face. This is more appropriate than constant velocity flumes in mimicking the natural velocity profile experienced by fish as they encounter a screened intake in the wild (Peake 2004). The first objective of this study was to quantify the ability of juvenile silver perch and golden perch to avoid contact and impingement when exposed to various velocities generated at an intake screen. To determine whether screen contact or impingement may be of any consequence to these species, the second objective was to quantify the rate of injury and mortality which followed contacts and impingements. In the wild, fish are likely to encounter screens at different times in the day and over a range of water turbidity which could affect their vulnerability at an intake screen. Therefore the third objective was to investigate the role that visual cues may play in mediating fish encounters with screens. This was done by comparing a subset of velocities under both low-visual light and zero-light conditions.

3.2 Methods

3.2.1. Fish collection and holding

Young-of-year (0+) golden perch (mean standard length = 41 ± 3 mm SD) and silver perch (mean SL = 51 ± 6 mm SD) were obtained from the Narrandera Fisheries Centre hatchery in March 2011. Fish were transported to the Port Stephens Fisheries Institute in plastic bags (approximately 300 fish per bag) filled with 20 L of dam water and sealed with a pure oxygen atmosphere. Prior to experimentation (and during post-trial recovery) the fish were held in a 10,000 L circular polyethylene holding tank, filled with bore-drawn water. The tank was situated next to a second 10,000 L tank which contained the experimental flume (Figure 11). The total volume of the system (20,000 L) was constantly exchanged between both tanks via a biological filter which was established five weeks prior to the arrival of fish. A heat exchanger maintained the water at an average temperature of 23.7 °C (range 19.4 - 24.9 °C) for the duration of the experiment. Within the main holding tank, each species was separated into a separate floating cage (1 x 1 x 1.5 m, 5 mm mesh net). An air stone in each cage helped to supplement oxygen levels which were monitored continuously.

To minimise the risk of stress-related disease following transport, the fish were given a prophylactic salt treatment which involved raising the salinity of the system to approximately 5 ppt for three weeks, and then maintained at approximately 4 ppt throughout the study. Prior to adding more bore water, temperature, pH, dissolved oxygen, salinity and conductivity were measured with a Horiba water quality meter to ensure they were within acceptable ranges. Low stocking density, adequate filtration and regular water quality monitoring negated the need for ongoing water changes beyond the initial prophylactic treatment. Water quality (temperature, pH, dissolved oxygen, salinity, conductivity) were constantly logged at 1 minute intervals (YSI Australia, Queensland, Australia) (Table 6). Ammonia levels were measured weekly and were never found to be at detectable levels. Automated fluorescent lighting was set on a 10 hour on-cycle to approximate a natural photo-period for the study location and time (the east coast of Australia during May). The fish were fed twice daily, with both species being fed *Chironomidae* sp. larvae and a commercial feed (silver perch - Aquafeed crumble, Ridley, Victoria, Australia; golden perch - Otohime Hirame, C1 granule, Aquasonic, New South Wales, Australia).

3.2.2. Experimental apparatus

An open-top, partially-submerged rectangular swimming flume was constructed from perforated aluminium plate screen (3 mm holes, 30 % porosity) (Figure 12). Perforated plate is a commonly used material to construct fish screens, being cost effective, strong and easily cleaned and maintained (Alan Richley, Oregon Fish and Wildlife Fish, Screening Program Coordinator, personal communication). To aid in observation, test fish were confined to a subsection of the entire flume and intake screen

using a cradle constructed out of the same perforated mesh (Figure 12a). Water was recirculated through the flume using a pump capable of delivering up to 1,950 L/min (Figure 11). Valves at the downstream end of the pump controlled flow through the flume, allowing variable slot velocities (SV) (see page *xi*) to be generated through a removable intake screen. Discharge through the flume was quantified in the pipe between the flume and the pump using an ultrasonic flow meter with doppler insert sensor (Series 2 Flo Pro, Mace, Sydney Australia) (Figure 12). The appropriate discharges required to generate a variety of SVs were calculated (as a function of screen surface area, porosity and volume of water moving through the flume). For each SV, a propeller-driven, digital flow meter (General Oceanics, Inc., Florida, U.S.A.) was used to take replicate velocity measurements in the flume at increasing distances from the screen face. From this the perpendicular velocity vector was plotted (Figure 13) and the approach velocity (AV) 8 cm from the screen determined for each slot velocity. The treatment velocity was maintained at the required level by continuously monitoring discharge throughout the trial.

3.2.3. Intake experiments

Each replicate for each treatment velocity consisted of introducing a test group of 10 individual fish into the flume. Fish were assigned to each replicate by dip-netting them out of the main holding cage prior to the start of each experiment. This approach to allocating fish to replicates resulted in an equal allocation of size ranges across the different treatment groups (One-way ANOVA; golden perch $F_{(5,294)}=1.97$, $p=0.0827$; silver perch $F_{(5,294)}=2.2$, $p=0.0546$). Apportioning equal size ranges was deemed important so that no particular treatment contained fish that were bigger or smaller than other groups, thus minimising bias arising from differences in swimming ability.

After being placed in the flume, fish were crowded to a point farthest from the intake screen using a divider. The divider was in place for 30 minutes, during which time they were exposed to a velocity of approximately one body length per second to acclimatise. Following this period, the flow in the flume was increased to the desired approach velocity at the screen face, the divider was removed and fish allowed to approach the intake screen. The treatment velocity was maintained for 60 minutes and fish behaviour recorded using a Sony DCR-HC21E video camera mounted on a tripod above the flume (Figure 11).

As anticipated, the velocity vector perpendicular to the screen decreased considerably with increasing distance from the screen face (Figure 13) and at the 1.3 and 1.5 m/sec SVs, AV was the same. The order of velocity treatments was randomised throughout the entire experiment (Table 7). Silver perch were subjected to SVs between 0.7-1.5 m/sec, equating to AVs between 0.2-0.4 m/sec. Golden perch were tested over a slightly lower range of velocities (0.5-1.3 m/sec SV or 0.15-0.4 m/sec AV), as they appeared to be weaker swimmers during pilot testing (personal observation). To quantify the potential rate of entrainment at an unscreened intake, five replicates of each species were also exposed to a 'no screen' treatment where the perforated screen was removed and replaced with a Perspex-backed screen with a 100 mm diameter hole cut into it and the velocity at this hole set at 2 m/sec (termed SV, but measured at the intake). When analysing the video, a 'no screen' replicate was deemed to have concluded once all fish were entrained.

All velocity treatments were run under a zero light condition (0 lux), by excluding ambient light from the flume using a black plastic cover. To enable video capture, the camera was set to 'night vision', and the flume within the vicinity of the intake screen was illuminated with a low power infrared light (52 mm diameter, 50 LED, wavelength \approx 850 nm, maximum radiant intensity \approx 200 mW/sr at 100 mA). The effect of visual light on fish behaviour at the intake screen was tested for both species over a sub-set of approach velocities (Table 7). It was hypothesized that increased light may facilitate an avoidance response if fish could visually observe the screen. To create a low level of visual light (1 lux at the surface), an incandescent 40 W bulb with dimmer switch was positioned directly above the swim chamber, pointing in an upward direction to produce a weak diffuse light across the entire flume. For the lighted condition, five replicate groups of silver perch were tested at SVs of 0.7, 1.1

and 1.5 m/sec (0.2, 0.35 and 0.4 m/sec AV) and five groups of golden perch were tested at SVs of 0.5, 0.9 and 1.3 m/sec (0.15, 0.3 and 0.4 m/sec AV). These were compared to the equivalent velocities tested under zero-light. For brevity here after, velocities will only be referred to in text as AV, however, both AV and SV will be shown in tables and figures.

Immediately following each 60 minute test, fish were dip-netted from the flume and placed in a 250 mm x 250 mm x 100 mm plastic recovery box with mesh sides and floated in the holding tank (Figure 11). At this time the number of dead fish were counted. After 24 hours, any further deaths were recorded and all remaining fish were euthanased in a solution of Ethyl-p-amino benzoate (100 mg/L) and inspected closely for signs of injury and then measured. Injury and mortality rates were compared to a handling control, where five replicates groups of each species were subjected to identical handling conditions to the velocity treatments, except that the 60 minute test period was carried out with zero approach velocity at the intake screen. Injury and mortality were not quantified for the 'no screen' treatment, as the vast majority of fish were either entrained during the experiment, or escaped the flume through the intake pipe once the pump was turned off.

3.2.4. *Statistical analysis*

Three behaviours were quantified from viewing video footage (Figure 12): 1) Approach – when a fish moved to within 5 cm of the intake screen; 2) Contact – when a fish touched the intake screen for less than 3 secs; and 3) Impingement – when a fish contacted the screen for a prolonged period (≥ 3 secs). Approach was expressed as a rate (number of approaches fish/minute). The probability that approaches would result in either a contact or impingement was expressed as a percentage. To assess differences in approach rate, probability of contact and probability of impingement (dependent variables) between velocity treatments, permutational analysis of variance (PERMANOVA) was used (Anderson *et al.* 2008). This produced a test statistic equivalent to the traditional F ratio but used a permutation procedure to assess significance, thus avoiding assumptions of normality. Separate one-factor models were used to compare dependent variables for each species among five different approach velocities and the 'no screen' treatment (fixed factor, six levels, 999 permutations under an unrestricted model). Two-factor models were used when examining the interaction between light (fixed, two levels) and a reduced number of velocities (fixed, three levels), this time conducting 999 permutations under a reduced model. When a factor was identified as significant at $p < 0.05$, post-hoc pairwise tests (t-tests) were conducted, again obtaining p-values using 999 permutations. One-factor permutational ANOVA (999 permutations under an unrestricted model) were used to compare the probability of injury for different approach velocities for each species.

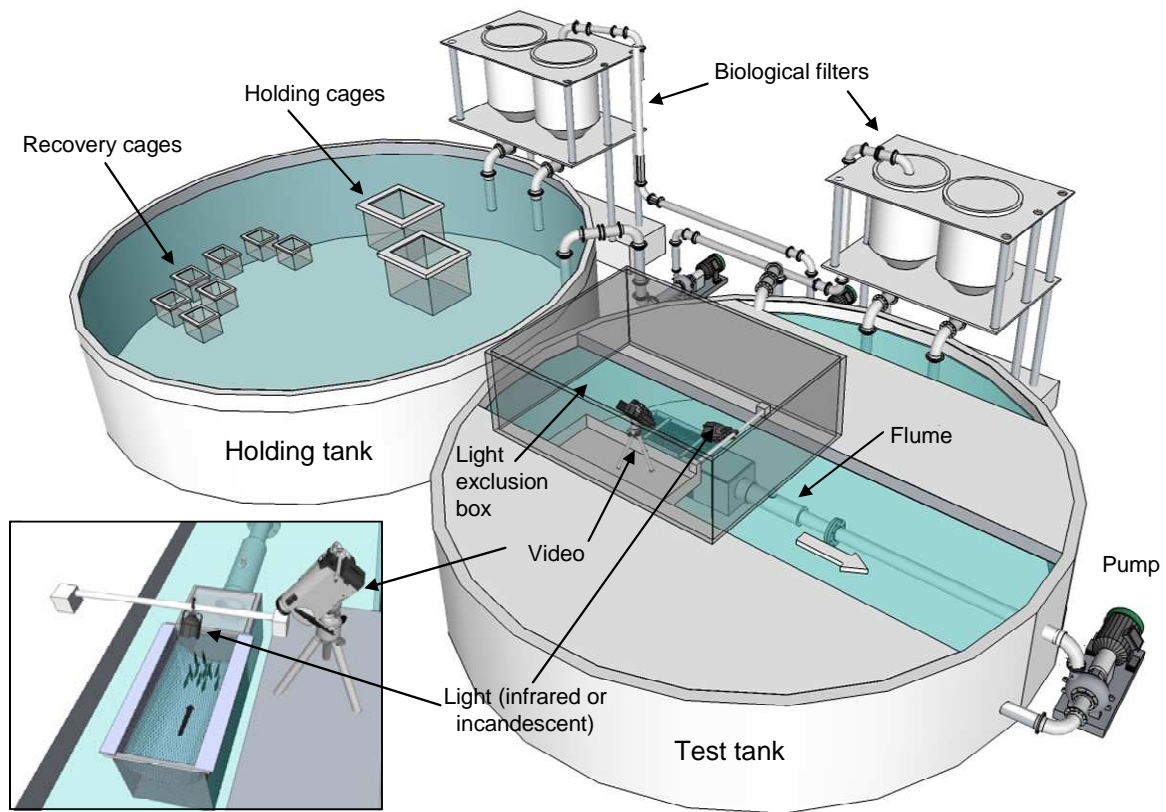
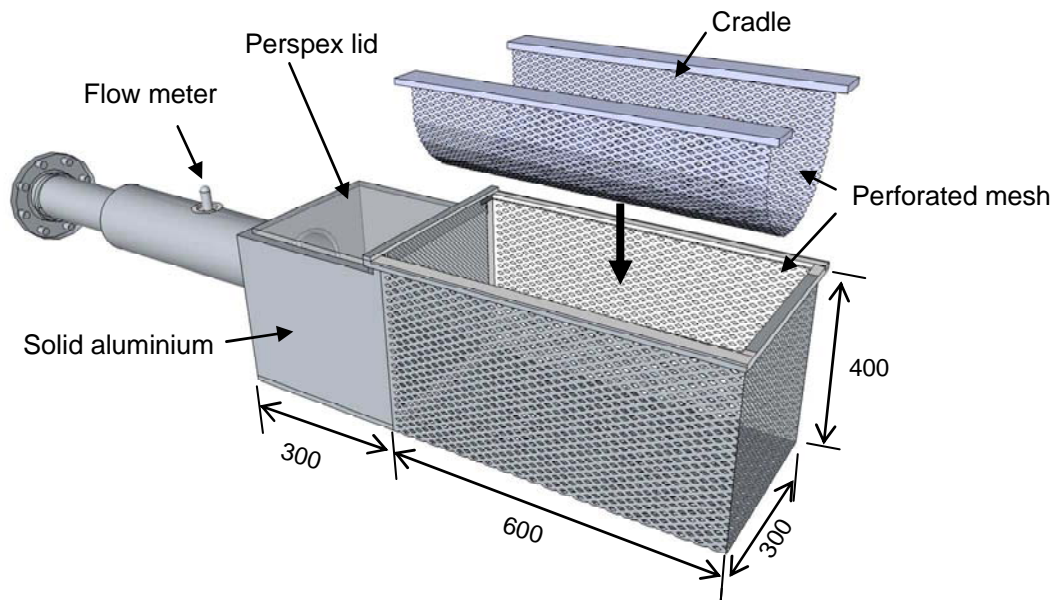

Figure 11. Overview of experimental setup showing the holding tank (left) and test tank (right) containing the flume (inset). Ambient light was excluded from the flume using black plastic and supplemented with either infrared light (zero light treatments) or a 40 watt incandescent light (lighted treatment).

a) Cradle-removed view



b) Cut-away view

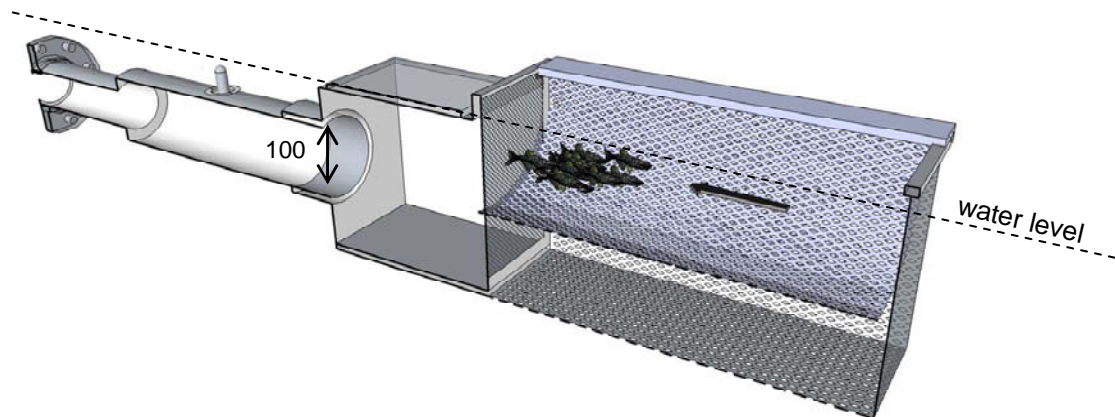

Figure 12. Experimental flume with a) cradle removed and b) cradle *in situ* with side wall cut away for viewing. All dimensions in mm.

Table 6. Summary of water quality in holding and test tanks during the study.

Parameter	Range			Mean	±	S.E.
Temperature (°C)	19.40	-	24.90	23.70	±	0.08
pH	8.20	-	8.77	8.48	±	0.01
Dissolved Oxygen (mg/L)	4.58	-	6.35	5.86	±	0.06
Salinity	4.20	-	5.80	4.09	±	0.04
Conductivity (mS/cm)	6.22	-	10.65	8.53	±	0.16

Table 7. Experimental design showing the number of replicate test groups allocated to each slot (SV) or approach (AV) velocity treatment and tested in either no light or low-light conditions. 'No light' refers to experiments at 0 lux, 'low light' refers to experiments at 1 lux.

Velocity (m/sec)		Golden perch		Silver perch	
SV	AV	No light	Light	No light	Light
0 *	0 *	5		5	
0.5	0.15	5	5		
0.7	0.2	5		5	5
0.9	0.3	5	5	5	
1.1	0.35	5		5	5
1.3	0.4	5	5	5	
1.5	0.4			5	5
2.0 †	0.8 †	5		5	

* handling control; † no screen

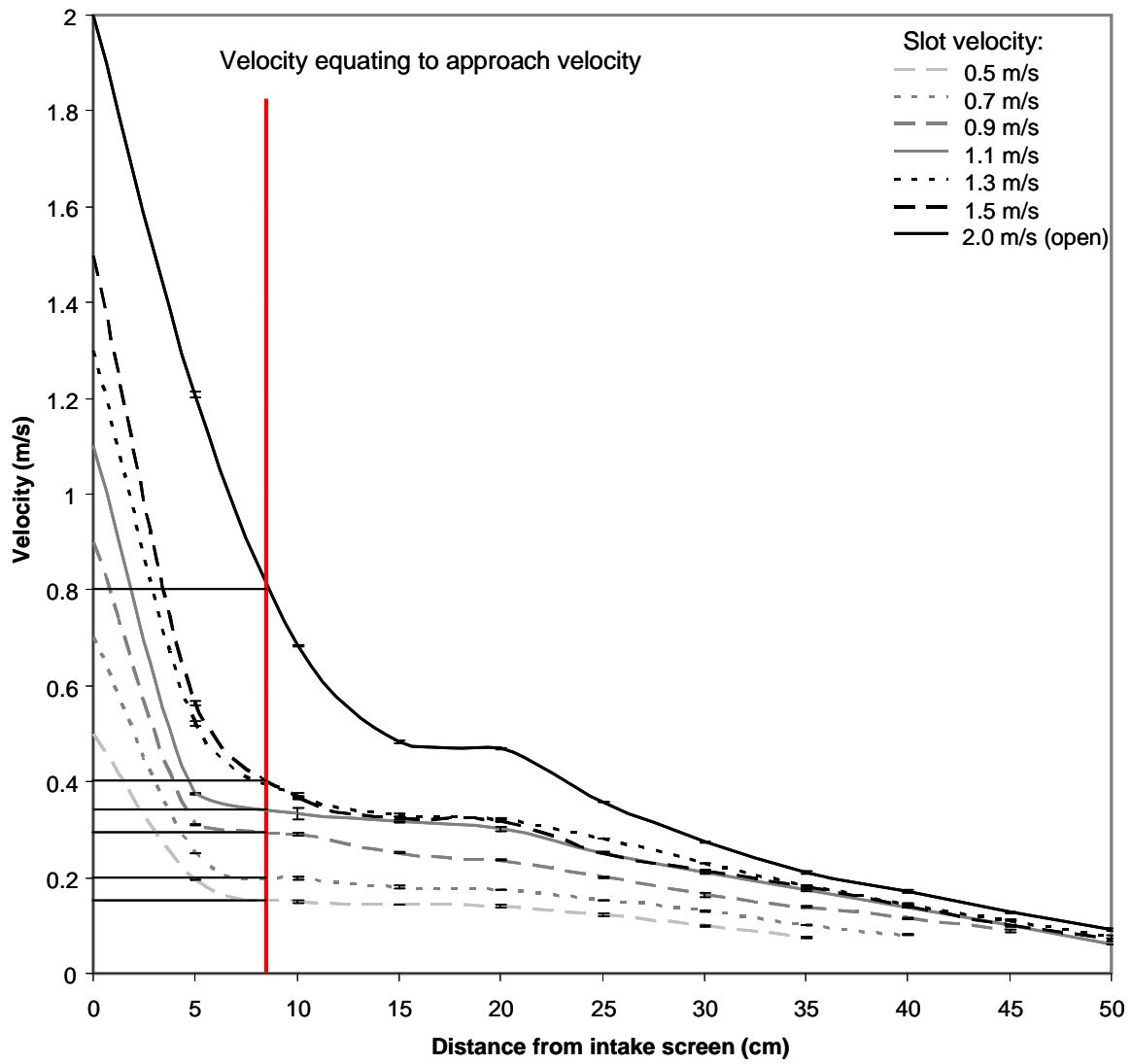

Figure 13. Velocity profile in the flume showing decreasing velocity perpendicular to the screen with increasing distance from screen. Profiles are shown for the different slot velocity (SV) treatments. The vertical lines signify the various approach velocities (AV) (measured 8 cm from the screen face) for each SV.

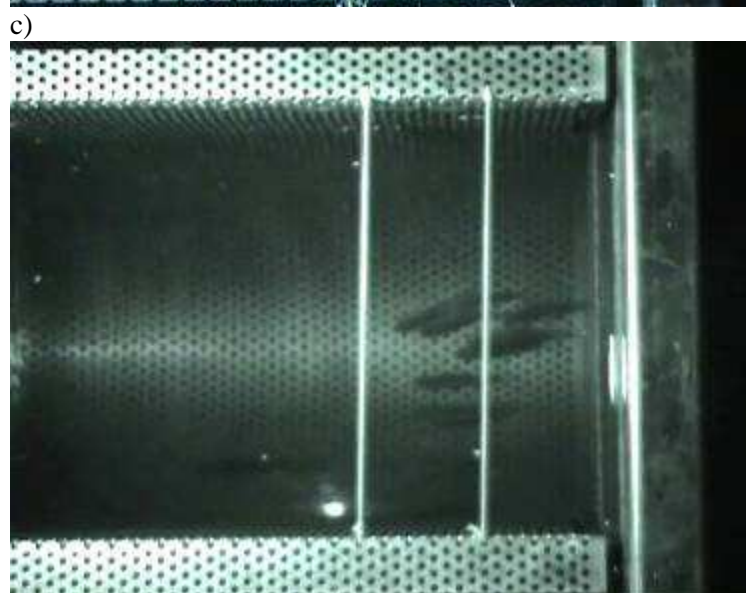
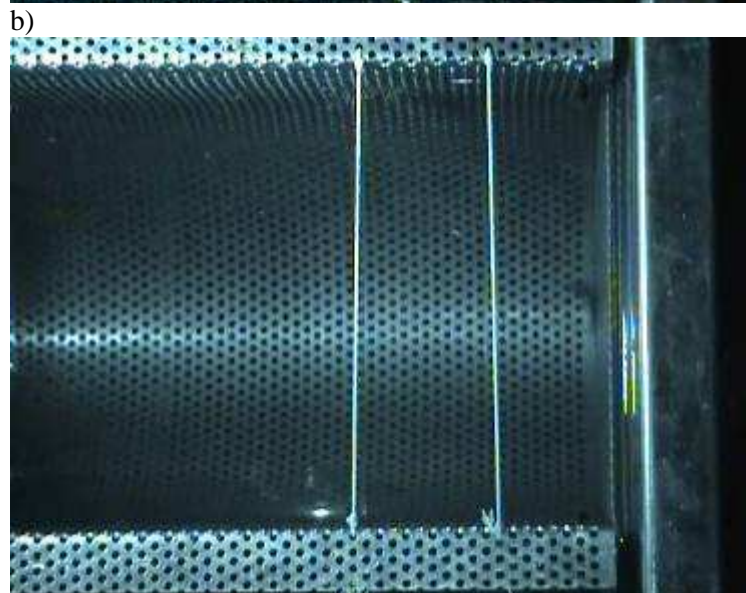
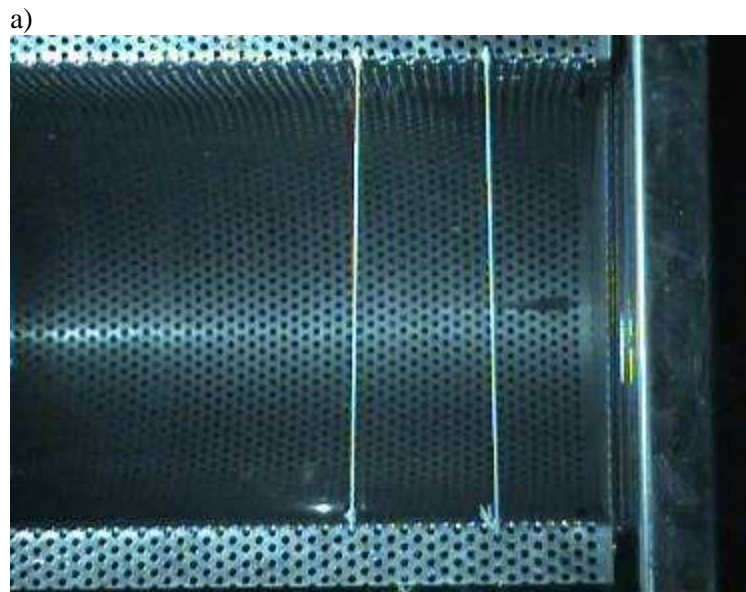

Figure 14. Examples of behaviours commonly observed: a) an approach, b) a contact (< 3 sec) or impingement (prolonged contact \geq 3 sec), and c) a school of fish displaying positive rheotactic behaviour in front of the screen face.

Conceptual representation of fish within the flume:



3.3 Results

Silver perch were more likely to approach the screen than golden perch (Figure 15). In the presence of a screen, silver perch averaged between approximately 1 and 2 approaches/fish/minute, with no difference in approach rate detected between the different velocity treatments. A significant increase in approach rate was measured in the absence of the screen, although this was primarily because all fish were typically entrained within the first few minutes of the trial, reducing the time of the trial and inflating the approach rate. Golden perch approached the screen much less than silver perch (never more than 0.6 approaches/fish/minute) and were significantly more likely to approach the intake when a screen was present. There was a trend of reducing approach rate with increasing velocity, and golden perch approached the screen significantly less once AV exceeded 0.3 m/sec.

Typically between 30 and 70% of screen approaches by silver perch and golden perch resulted in a screen contact, but very few of these resulted in impingement (Figure 16). The probability of screen contact differed among velocity treatments for silver perch but not golden perch. The probability of impingement was not influenced by velocity for either species. There was a trend of decreasing probability of screen contact for silver perch as velocity increased. Silver perch were less likely to contact a screen at 0.35 m/sec AV when compared to 0.2 m/sec AV and probability of contact was also significantly lower at 0.4 m/sec AV than at 0.2 or 0.3 m/sec AV. In comparison, the probability of contact for golden perch remained above 50 % and largely unchanged as AV increased above 0.2 m/sec.

On average, 96 ± 4 % of silver perch and 58 ± 12 % of golden perch were entrained (equating to mortality) by the intake in the absence of the screen. Mortality rates were comparatively low in the presence of a screen (Table 8), with very few silver perch (1.0 ± 0.7 %) or golden perch (1.7 ± 0.7 %) dying within 24 hours of experimentation. Injury rates were considerably higher for both species (Table 8), but no velocity treatment was found to have higher rates of injury than the handling control (Figure 17) and no correlation was found between the rate of contact or impingement and the number of fish recorded as injured (Table 9). Fin damage was the most frequently recorded injury type (Table 8).

Silver perch had a significantly lower approach rate in the dark than when under light (Figure 18 and Table 10). There was a significant interaction between light and velocity because the difference between light and dark approach rates were more marked at the lower velocities and not significantly different at the highest velocity tested (0.4 m/sec AV). The probability that silver perch would contact the screen decreased with increasing velocity, but the probability of contact was higher in the dark than it was under light, in all but the lowest velocity tested (0.2 m/sec AV). Although impingement rates were low across all treatments, there was a significantly higher probability of impingement in the dark at the highest velocity tested. Like silver perch, golden perch also had a significantly lower approach rate in the dark than when under light (Figure 18 and Table 10), but the probability of contact and impingement appeared unaffected by light levels.

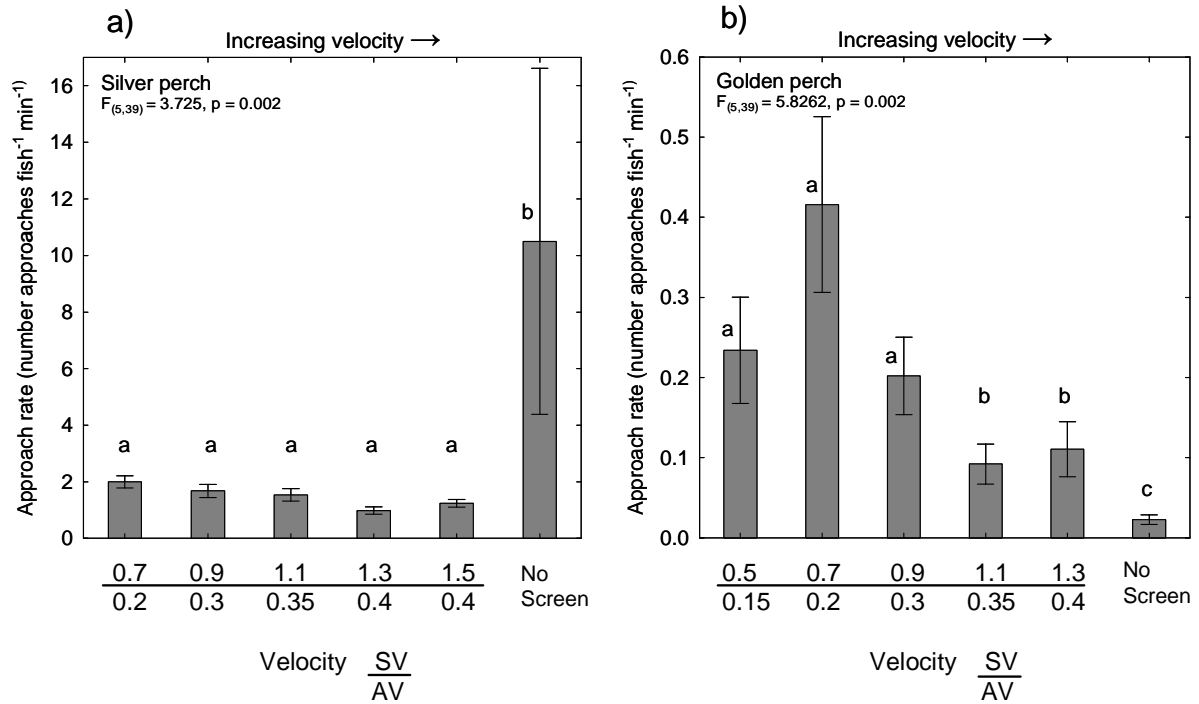

Figure 15. Mean (\pm SE) rate that a) silver perch and b) golden perch approached the experimental screen across the various slot (SV) or approach (AV) velocities (m/sec) and no screen treatment. Different letters represent significantly different treatments ($p < 0.05$) determined by pairwise comparisons. Note the different scales on the y axis.

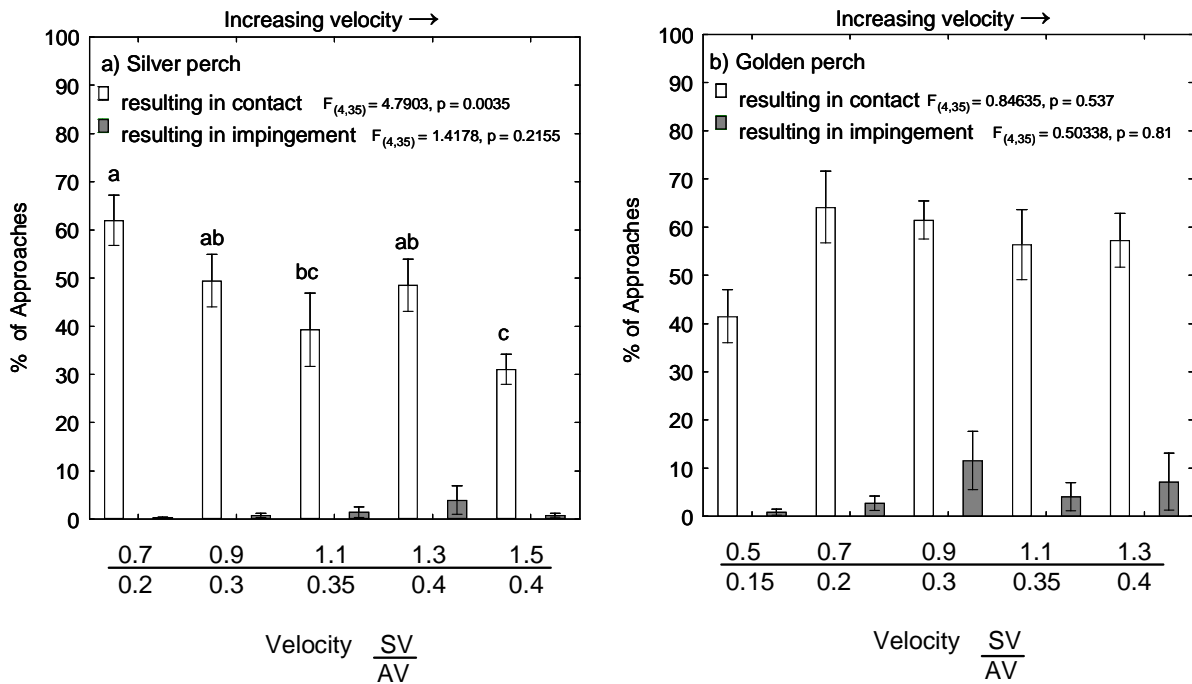
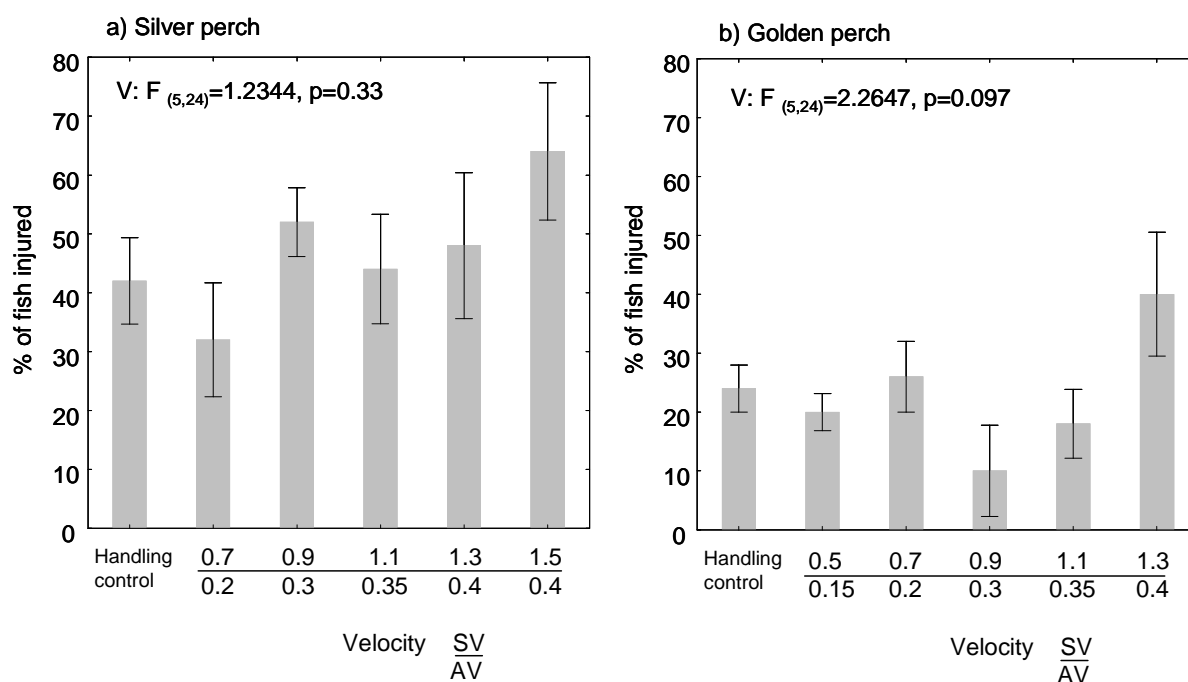

Figure 16. Mean (\pm SE) probability of screen contact and impingement resulting from a screen approach in a) silver perch and b) golden perch, between the different slot (SV) or approach (AV) velocities (m/sec). Where an overall significant treatment effect was found, significantly different groups ($p < 0.05$), determined by pairwise comparisons, are indicated by differing letters.

Table 8. Number of silver perch and golden perch dead or showing signs of injury within 24 hours of experimentation. The 'no screen' treatment has been excluded.

Category	Silver perch	Golden perch
Unharmed	336	377
Dead within 24 hours	3	5
Injured within 24 hours	111	68
Fin damage	102	58
Scale damage	9	7
Head damage	0	0
Eye damage	0	0
Haemorrhage	0	3
Total number of fish	450	450

**Figure 17.** Mean (\pm SE) percentage of fish showing signs of injuries (24 hr post experiment) for each slot (SV) or approach (AV) velocity compared to the handling control. Results of one-way permutational ANOVA shown.**Table 9.** Correlations between the number of fish injured and the contact and impingement rate of silver and golden perch exposed to the simulated intake screen.

		<i>r</i>	<i>p</i>
Silver perch	Contact rate versus number of injured fish	-0.1951	0.3014
	Impingement rate versus number of injured fish	-0.0365	0.848
Golden perch	Contact rate versus number of injured fish	0.0657	0.7302
	Impingement rate versus number of injured fish	-0.0365	0.848

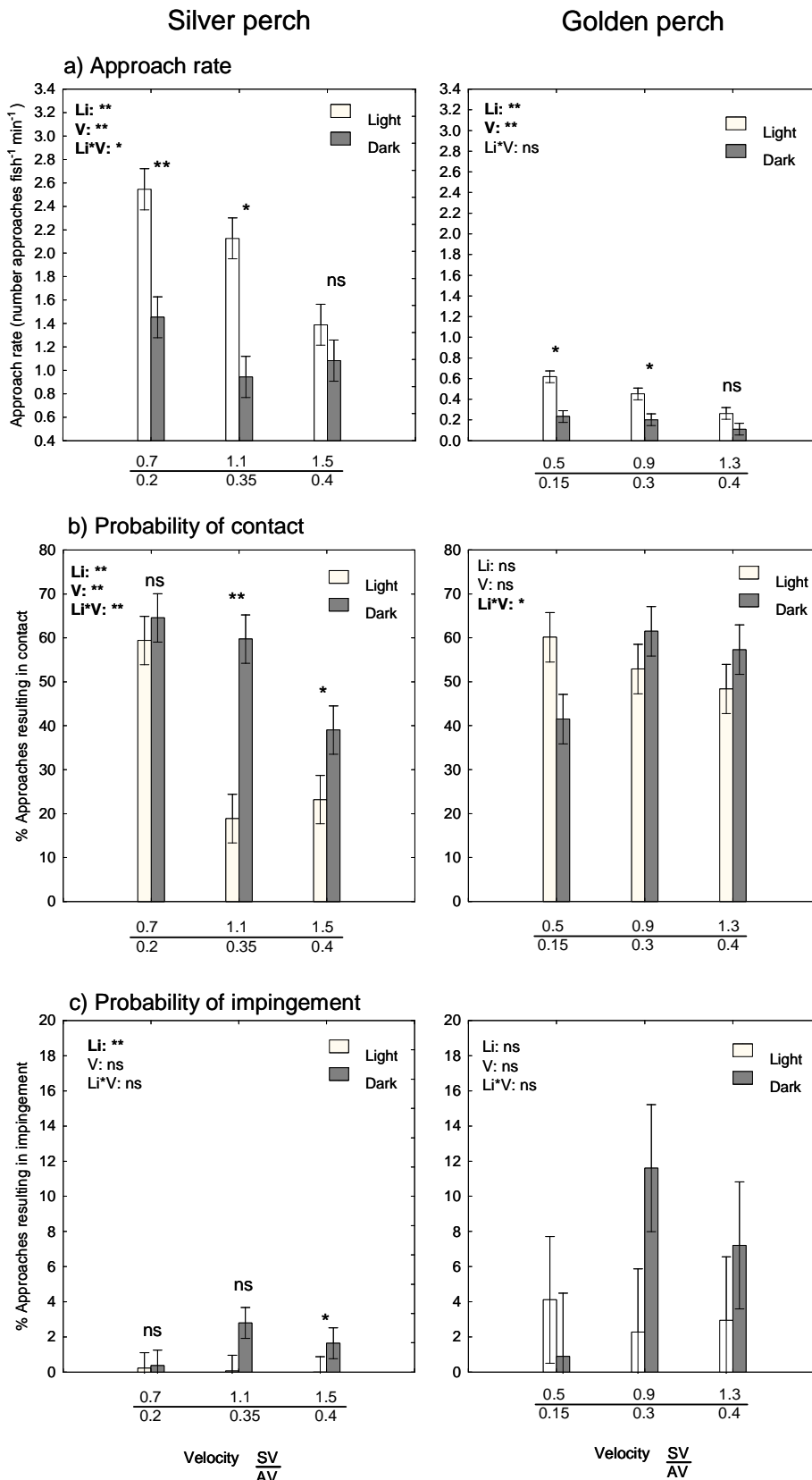

Figure 18. Mean (\pm SE) approach rate (a) and probability that an approach resulted in a contact (b) or impingement (c) for silver perch (left) and golden perch (right) for different slot (SV) or approach (AV) velocities (AV, m/sec) and light (Li) treatments. Significance levels of main-effects ANOVA are shown for each factor and interaction (detailed in Table 10). Where Li was found to be significant, pairwise comparisons for each pair of Li within each AV was conducted and significance level indicated above the bars. Significant at * $P < 0.05$, ** $P < 0.01$, NS: non significant.

Table 10. ANOVA results partitioning variance of the factors light and approach velocity and the interaction of these, for approach rate and the probability of approaches resulting in contacts and impingements, for both silver perch and golden perch.

Source of variability	df	Approach rate			Probability of contact			Probability of impingement		
		MS	<i>F</i>	P	MS	<i>F</i>	P	MS	<i>F</i>	P
Silver perch										
Light (Li)	1	5.5527	36.056	0.001	3186.5	21.035	0.001	16.957	4.3775	0.009
Velocity (V) †	2	1.4781	9.5979	0.001	2558	16.886	0.001	3.241	0.83668	0.537
Li*V	2	0.5803	3.7681	0.028	840.82	5.5506	0.009	4.2431	1.0954	0.400
Residual	24	0.154			151.48			3.8736		
Golden perch										
Light (Li)	1	0.51658	31.941	0.001	0.99031	0.06279	0.956	89.748	1.3779	0.293
Velocity (V) †	2	0.14458	8.9397	0.001	106.19	0.67335	0.530	49.738	0.7637	0.506
Li*AV	2	0.0393	2.098	0.145	625.55	3.9665	0.044	99.773	1.5319	0.257
Residual	24	0.01617			57.71			65.132		

† This only includes data for the subset of velocity treatments where light levels were compared (see Table 7).

3.4 Discussion

Laboratory experiments determined that the physical encounter between juvenile silver perch and golden perch and an intake screen was defined by a combination of flow conditions near the screen and behaviour of individual fish. Juvenile silver perch and golden perch behaved differently when a screen was encountered. Golden perch actively avoided higher velocity regions by engaging in positive rheotactic behaviour which was enhanced as velocity increased. Chinook salmon *Oncorhynchus tshawytscha* exhibit similar behaviour when approaching screens (Swanson *et al.* 2004). By comparison, juvenile silver perch were more likely to enter higher velocity regions in front of the screen and appeared more able than golden perch to successfully negotiate these higher velocity regions, leading to decreased contact probability. The difference observed in behavioural response and contact rates may suggest that avoidance responses are species-specific.

Both silver perch and golden perch made more screen approaches under lighted conditions, particularly at lower approach velocities. Silver perch were also more likely to contact the screen at higher approach velocities in darkness. Together these observations indicate that rheotactic responses to flow are in part influenced by visual cues, leading to an increased ability to negotiate higher approach velocities under lighted conditions. In darkness, positive rheotactic behaviour was enhanced and fish mostly avoided the screen but when fish did approach the screen, the probability of contact was far greater. Swanson *et al.* (2004) made a similar observation of juvenile Chinook salmon at an intake screen under different light conditions which suggests that under darkness, fish rely more upon flow conditions to guide movement but under lighted conditions they supplement this rheotactic response with visual cues. Such an observation is significant for the development of screening criteria for the Murray-Darling Basin, as the lowland rivers are typically high in turbidity and fish are therefore less likely to have the capacity to utilise visual cues when they encounter fish screens. The same scenario would exist for fish which encounter a screen at night. Criteria developed for fish under lighted conditions could therefore underestimate the impact of certain screen criteria when applied in the wild. It is recommended that future studies aimed at developing screen criteria for fish do so under conditions of no light.

Adding a screen afforded a significant level of protection for the juvenile fish tested in this study. Without a screen the majority of golden perch (58 %) and silver perch (96 %) were entrained at the intake, with lethal consequences. Fish also contacted the screen when it was present but these contacts rarely resulted in impingement across the entire range of velocities tested. Importantly, neither contacts nor impingements were lethal or caused many short-term injuries (when compared to the handling control). The reductions in mortality rate provided by a screen were significant, reducing to below 2 % for these species when a screen was present. Furthermore, injury rate when a screen was present was not correlated with approach velocity, rate of contact or impingement, suggesting that neither golden perch nor silver perch were adversely affected by an intake screen operating at approach velocities as high as 0.4 m/sec. If these reductions in mortality rates can be extrapolated to what may be expected in the field, our results suggest that intake screens operated at these velocities have great potential for protecting Murray-Darling fish species at water diversions.

Laboratory experiments are most beneficial if representative of the environmental conditions in a real-world setting, but this is not always the case. For instance, estimates of fish swimming ability obtained from swim tunnel experiments often poorly predicted fishway ascent probability for Australian species, (Mallen-Cooper 1992). In the current study the flume was created to simulate a screened river intake, where velocities significantly decreased with increasing distance from the intake screen. Under these conditions fish needed only a short burst speed to access regions of slower velocity to avoid impingement (Peake 2004). This aside, there is always the possibility that by using hatchery-bred fish, which may have poorer swimming ability than wild fish (Bams 1967, Taylor and McPhail 1985), or by constraining fish within a flume, rates of contact and impingement may have been overestimated. Observations made at an experimental intake screen in a riverine setting have shown that undefined Murray-Darling Basin fish species between 40 and 50 mm had approximately a 40-45 % probability

of contacting the intake screen at approach velocities of 0.5 m/sec and 15-20 % probability at approach velocities of 0.1 m/sec (see previous chapter Figure 10). In the experimental flume, golden perch of an equivalent size had slightly higher probability of screen contact (approximately 60 and 40 %) over similar approach velocities (Figure 16b). Although there is no way of determining whether the same species were being observed in the field trials, it may suggest that criteria deemed appropriate in the laboratory maybe somewhat conservative, but still likely to afford adequate protection for fish in the wild. Screening criteria developed based on laboratory testing could benefit from subsequent field verification.

In conclusion, a perforated plate screen operating at approach velocities up to 0.4 m/sec (1.5 m/sec SV) had few lethal and sub-lethal impacts on juvenile silver perch and golden perch. Further, the presence of the screen significantly reduced the level of mortality that arose by entrainment at an unscreened intake. In the absence of any existing fish screen criteria for Murray-Darling Basin species it is recommended that for screens made of perforated plate, approach velocities of up to 0.4 m/sec would provide adequate protection for juvenile silver perch and golden perch. Further research is warranted on other species and age classes, particularly if it is desirable to devise design criteria which will protect a wide range of species and life history stages vulnerable to diversion. Additionally, it would be beneficial to repeat experiments on juvenile silver perch and golden perch at higher approach velocities to determine upper critical limits of swimming capabilities at intake screens. Doing this will help guard against developing overly-conservative design criteria, which will lead to unnecessarily big and expensive screens. Small experimental flumes, such as the one used here, will be a useful tool for undertaking these further studies, since they allow rapid testing of a large number of species, life history stages and treatments, including screen materials and approach velocities.

4. REVIEW OF FISH SCREENING PROGRAMS IN THE UNITED STATES OF AMERICA: LESSONS FOR THE MURRAY-DARLING BASIN.

4.1 Introduction

Intake screens are commonly used to reduce fish losses at water diversion points (Moyle and Israel 2005). Fish screening laws date back to the late 1800s in the United States and the sheer number of fish impacted by some diversions was first quantified early last century (Brannon 1929). Since that time, substantial resources have been devoted to the research and development of screening technologies and there has been a steady evolution from a non-systematic, largely ineffective, *ad hoc* approach to screen design and installation, to the ‘modern era’ of screening where programs are more strategically coordinated and prioritised, well-resourced and backed by an evidence based-approach (e.g. McMichael *et al.* 2004, Peake 2004, Cech and Mussen 2006, White *et al.* 2007). Considerable uncertainty still exists over the cumulative contribution of large-scale screening programs to the sustainability of fish populations but there is little doubt that, at times, large numbers of fish can be lost by diversions and that fish screening is an important conservation tool for guarding against population declines and localised extinctions in some areas (Moyle and Israel 2005).

There is presently no fish screening program in the Murray-Darling Basin and it is desirable that any emerging programs consider the successes and failures of others. To this end, this chapter reviews some of the key features of screening programs on the Pacific Coast of the United States of America (encompassing the States of Oregon, California and Washington and referred to hereafter as the ‘Pacific Coast’), that are of direct relevance to an emerging program in the Murray-Darling Basin. We contend that in order to address this significant fisheries management issue, there is no need to re-invent the wheel, but appreciate the difficulties and successes of established and emerging technologies that have manifested over the last century. The key objective of this chapter is to provide a list of recommendations to assist managers and researchers to begin tackling this significant, but only recently acknowledged, conservation issue in the Basin.

4.2 Do we know enough about the extent of the problem in the Murray-Darling Basin to begin action?

Research quantifying the number of fish lost at irrigation diversions in the Murray-Darling Basin is limited, but the few studies that have been conducted suggest that the problem may be substantial (King and O’Connor 2007, Baumgartner *et al.* 2009). There is evidence that a diverse range of fish species can be entrained by both pumps and gravity fed diversion canals. Larger-bodied fish have been shown to enter irrigation canals or be entrained in pumps, whilst early life stages (eggs, larvae and 0+ or first year of life) appear to be the most affected, based upon their dispersal strategy and poor swimming ability (Gilligan and Schiller 2003, King and O’Connor 2007, Baumgartner *et al.* 2009). Early life stages of Murray cod *Maccullochella peelii peelii*, golden perch *Macquaria ambigua*, silver perch *Bidyanus bidyanus* and trout cod *Maccullochella macquariensis* have downstream drifting phases which correspond to peak periods of irrigation abstraction (November and December) (Gilligan and Schiller 2003, Humphries and King 2004). Larval drift studies within the main river channel and irrigation canals show that during peak breeding seasons millions of Murray cod and trout cod larvae and the eggs of golden perch and silver perch are potentially vulnerable to abstraction from the main river (Gilligan and Schiller 2003, King and O’Connor 2007).

Fish entrainment at diversions in the Pacific Coast can reach many million individuals (Allen 1975, Spaar 1994). Numbers entrained are usually correlated to the number of fish in the river and the amount of water being diverted. A similar relationship has been observed in the Murray-Darling Basin (King and O’Connor 2007, Baumgartner *et al.* 2009). The volume of water diverted during peak irrigation times often exceeds downstream flow at some sites within the Murray-Darling Basin

(Thoms *et al.* 2004, Baumgartner *et al.* 2007, King and O'Connor 2007), thus increasing the probability of fish entrainment. McMichael *et al.* (2004) contend that the extraction of even a small percentage of egg and larval production may represent a substantial loss of potential recruits from main river environments. This is likely to have major implications for the sustainability of Murray-Darling fish populations, since it is felt that poor recruitment over several decades, rather than poor spawning, can be responsible for differences in fish faunas between rivers (Humphries *et al.* 2002).

Although the limited studies available raise significant concern over the impact of diversions on fish populations in the Murray-Darling Basin, there is still not enough information to fully appreciate how this is affecting populations at a Basin scale. It is important to ask; do we know enough about the impact to proceed with developing a screening program? King and O'Connor (2007) have suggested that effective management solutions cannot be progressed until the true spatial extent of the problem is understood. Quantifying the extent and variability of the problem may be useful from a resource allocation perspective, but will only likely highlight spatial and temporal variability in impacts (Moyle and Israel 2005) and not eliminate the need for a mitigation program. Most fish screening programs in the United States apply a precautionary approach to fisheries management (Dayton 1989), where diversions are assumed to harm fish unless proven otherwise (Moyle and Israel 2005). There is an accepted recognition that even small diversions have the capacity to impact fish populations under certain circumstances and policies requiring most diversions to be screened are strictly enforced in sensitive areas (McMichael *et al.* 2004).

Adopting a similar precautionary approach to screening, with research dollars better spent on refining biological criteria for screen design rather than on further quantifying entrainment rates, would be a far more cost-effective investment for the Murray-Darling Basin. Such an approach has already been demonstrated to be hugely successful in restoring fish passage to 2,225 km of the Murray River between the sea and Hume Dam (Barrett *et al.* 2008). This program saw the remediation of 14 main-stem barriers with fishways, without the need for detailed quantification of the relative severity of each barrier.

4.3 An evidence based approach to developing screen design criteria

There is more to protecting fish at water diversions than simply installing an exclusion screen with mesh fine enough to exclude targeted species or size classes. Although mesh size can dictate the sizes of fish which may be entrained into diversion intakes, the hydraulic conditions at the screen face are just as important (if not more so) since it determines a fish's ability to escape screen contact or impingement (prolonged contact). If contact and impingement are severe enough to lead to injury or mortality, than the impact of the diversion is not being negated by the presence of the screen. The tendency for a fish to escape entrainment or impingement typically relates to both its swimming ability and velocities generated at the screen face, particularly the velocity vector perpendicular to the screen (approach velocity) relative to that along the screen face (sweeping velocity) (Swanson *et al.* 2004, 2005a). These velocities are a function of stream flow, diversion discharge and screen design features such as screen material (e.g. bars, mesh or perforated screen), its porosity, size and how it operates.

Guideline documents are useful to inform constructing authorities and stakeholders interested in advancing the installation of screens given the complex nature of screen design and biological performance (Anon 1997, Nordlund and Bates 2000). Having clear and quantifiable design criteria has been a critical feature of fish screening programs in the Pacific Coast. Screening programs in this region typically adopt the National Marine Fisheries Service (NOAA Fisheries) criteria for fish screen design (NMFS 1997), although others do exist (e.g. CDFG 2000). The guidelines have a particular focus on endangered salmonids based on requirements of the Endangered Species Act, Federal Power Act and the Fish and Wildlife Coordination Act. There is provision, however, to develop additional criteria where there is the opportunity to protect other endangered species at a site (NMFS 1997). Similarly, the CDFG (2000) guidelines also allow provision for other endangered species such as delta smelt *Hypomesus transpacificus*. The guidelines try to maintain some degree of generality and acknowledge that criteria may need to be flexible to accommodate site specific constraints (NMFS 1997), but also clearly stipulate critical thresholds which should not be exceeded with respect to

aperture size of screening material and approach velocities, which in turn vary based on the age class of species present and type of cleaning mechanism employed. Other, more descriptive guidelines involve sweeping velocity (e.g. must exceed approach velocity), screen submergence, intake and screen position, and design features of fish bypasses (channels diverting fish from the screen face back to the river channel) such as pipe depth, diameter, discharge location and internal water pressure (NMFS 1997).

No screen design guidelines currently exist for Australian native fish and they will need to be developed as a matter of urgency. Guidelines developed for the Pacific Coast will undoubtedly be useful, particularly for screening material, screen positioning, maintenance and the performance of bypass channels. Approach velocity, however, will need to be a feature of primary consideration when developing new guidelines for the Murray-Darling Basin. Not only will this criteria need to accommodate a more diverse range of migratory species with very different swimming abilities to salmonids species (Mallen-Cooper 1999), but also incorporate a smaller size range of fish, maybe even early life stages such as the eggs and larvae of some species. Most importantly, the Pacific Coast experience demonstrates that development of any criteria should be backed by rigorous biological experimentation and in-field compliance testing (McMichael *et al.* 2004). The most effective way of doing this will be by using laboratory studies of fish swimming capabilities and injury and mortality rates at simulated screens, where variables of interest (e.g. approach velocity) can be adequately controlled in a replicated and experimentally robust way (e.g. Zydlewski and Johnson 2002, Peake 2004, Swanson *et al.* 2005a, White *et al.* 2007). It should be expected that research will be ongoing and that screening criteria may have to be revised as more information relating to different species and age classes comes to hand.

4.4 Applying existing technologies in the appropriate context

There are a wide variety of screen technologies being implemented in the USA which have direct applicability to the Murray-Darling Basin (Table 11 and Figure 19). There are several good sources of information on the relative merits of different fish exclusion technologies and these should be consulted when planning to screen a diversion (e.g. U.S. Department of the Interior 2006). Generally there are two main types of diversions in the Murray-Darling Basin; pump intakes as typified in the northern Basin and gravity fed canals, as typified in the southern Basin (Baumgartner *et al.* 2007). Within these two major categories, there are a huge range of site specific differences in design, discharge and intake positioning that will necessitate a diverse range of engineering solutions. Continual improvement in design has enabled self-cleaning solutions that can be operated by solar power or without the need for power altogether. These options are worth considering for remote and sediment-laden rivers in the Murray-Darling Basin.

There are several benefits in adopting existing screening technologies in the Murray-Darling Basin. Firstly, the technologies have often been developed, tested and refined over many years. As a result, their performance and associated benefits and limitations are well established and they could be directly applied to the Murray-Darling Basin with very little further developmental work. Another benefit is that the costs associated with their construction, installation and maintenance are already known and readily available (Kepshire 2000), which in-turn provides Government bodies, funding programs and irrigators with the certainty required to develop budgets and invest in infrastructure. Given the significant size of the fish screening industry in the Pacific Coast, fabrication shops have been established to mass produce screens, a feature that helps to keep the costs down. Some technologies, such as rotating pump screens, are commercially available and could be imported directly from the USA using the internet.

Table 11. Fish Diversion screens with high potential for direct application in the Murray-Darling Basin.

Screen type	Features and suitability within the MDB	Summary of Murray-Darling Basin suitability				
		Small pump site (<100 ML/day)	Large pump site (>100 ML/day)	Small gradient-fed canal (<1000 ML/day)	Large gradient-fed canal (1000-10000 ML/day)	Instream weirs dams
Rotary drum	Screens fitted to rotating drum. A slow rotation of the mesh allows debris to be effectively removed thus preventing fouling. Suitable for low gradient, smaller diversion canals in the southern MDB. Simple engineering keeps costs down. Can be powered by solar or paddle wheel for sites without electricity supply. Can be made to suit canals with variable discharge by operating multiple bays or screens side-by-side (more screens are brought online as flow rate increases and shut-off as flow decreases).	No	No	Yes	Yes	Only when water is discharged over a fixed crest
Belt	Has a mesh panel which vertically rotates in a manner analogous to a conveyor belt. This design requires low velocities at the screen to prevent fish impingement. It is self cleaning and debris simply collects and rotates with the screen. Requires power and is more expensive than other types. Probably limited application at most diversions in the MDB, other than large dams in junction with downstream fish bypasses.	No	No	No	Potentially, but not first choice	Yes
Vertical Panel	Suitable for larger gradient fed diversion channels such as found in the lower MDB. Capable of accommodating greater fluctuations in river flow than rotating drum as submergence depth less critical. Needs to have an electric driven brushing mechanism, typically in tandem with setting at appropriate angle to facilitate sweeping velocities across the screen face. * There is an example of one doing 300 ML/day in Oregon, but there is no reason why they could not be built to accommodate diversions such as Yarrawonga (3,400 ML/day) or Mulwala (8,000 ML/day)	Potentially, but not first choice	Potentially, but not first choice	Yes	Yes	Yes

Pump screens: Rotating pump (e.g. Sure Flow®) or brushed cylinder (e.g. ISI)	Rotating pump screens for small diversions (up to 30 ML.day ⁻¹ when two run in tandem) can be purchased directly off the internet. Self cleaning by way of internal jet that sprays inside of rotating mesh screen (no power required). Possibly suitable for reducing the entrainment and impingement of larval and eggs stages (although this needs to be verified). For larger pump sites, rotating wedge wire cylinders (powered) with internal and external brushes can be custom built for any discharge pump (e.g. ISI 2010).	Yes: rotating pump (<30 ML/day), brushed cylinders (>30 ML/day)	Yes (brushed cylinders)	No	No	No
Horizontal screen	Could be suitable for low-gradient diversion canals and have been demonstrated to be suitable for screening intakes to hydro electricity units placed on weirs. Farmers Conservation Alliance (FCA) has a patent on a unique design (Farmers Screen) which has low approach velocities and is self cleaning whilst allowing 90 % dewatering (10 % for fish passage). Design specifications available from FCA on request.	No	No	Yes	No	Yes

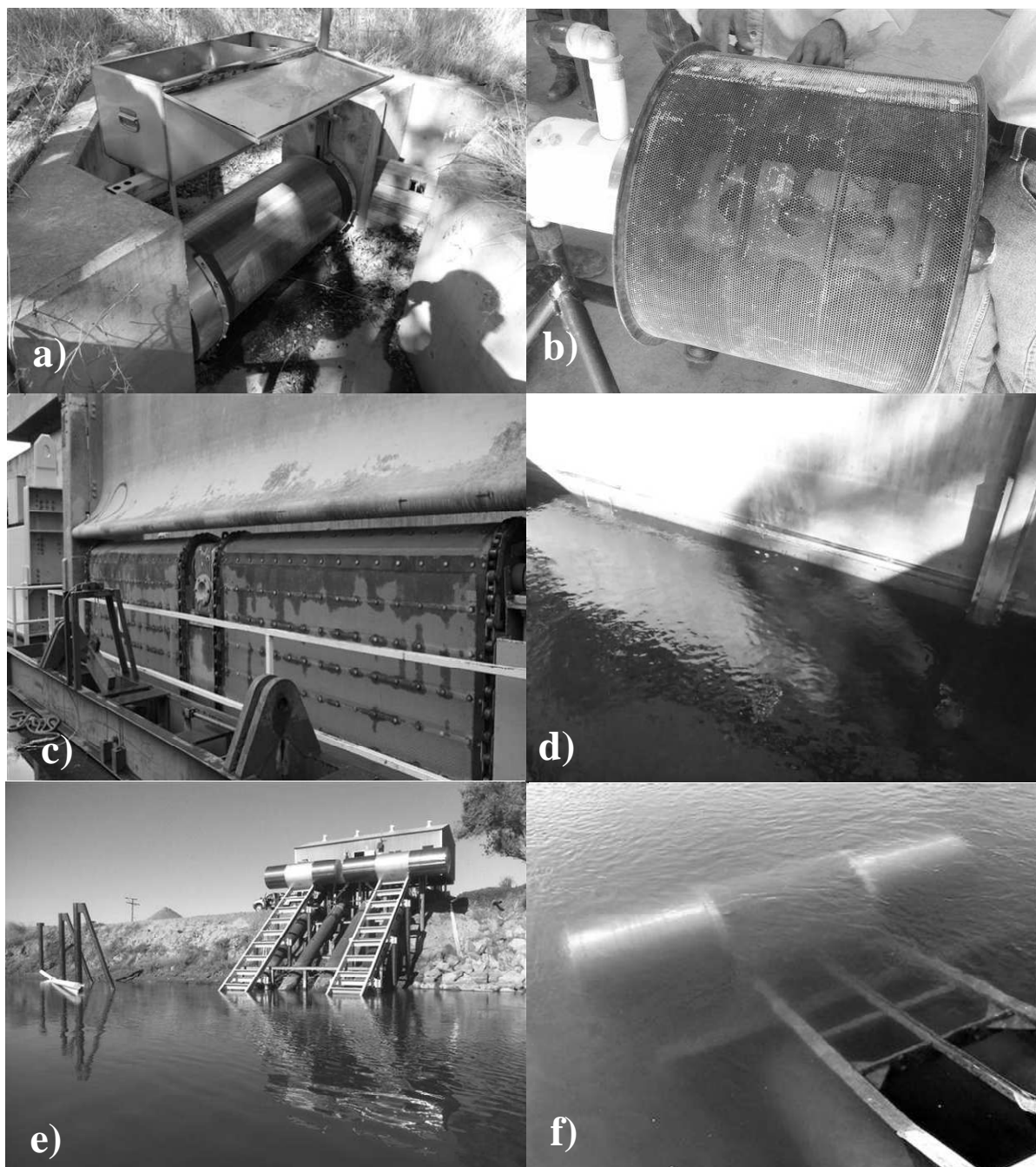

Figure 19. Various screen designs for potential application in the Murray-Darling Basin. (a) rotary drum screen, (b) rotating pump screen with rotating head and internal jet, (c) travelling belt screen, (d) vertical panel screen (submerged) with travelling brush and (e & f) brushed cylinder pump screen (e & f reproduced with permission of Intake Screens, Inc.).

There are likely to be many instances where retrofitting existing intakes with existing technologies will be difficult and site-specific solutions will need to be developed and this should be acknowledged in screening guidelines (NMFS 1997). There will also be instances where existing technologies may provide unique solutions for the Murray-Darling Basin. For instance, the self cleaning properties of rotating pump screens, whilst designed to prevent fouling when exposed to high debris loads, may provide an innovative solution to the impingement and entrainment of eggs and larvae. This warrants further research.

4.5 Maximising adoption

There are two main tools available to assist in screen adoption: legislation (or regulation) and incentives. Elsewhere in the world, legislative obligations associated with endangered species are a common driver for fish screen development (Moyle and Israel 2005). Presently, irrigation screening legislation exists in North America (NMFS 1997, CDFG 2000), New Zealand (Jamieson *et al.* 2005), United Kingdom, Ireland, Switzerland, Netherlands, Denmark (Turnpenny *et al.* 1998) and France (Larinier 2008). Most fish screen guidelines in these countries, except New Zealand, were developed to protect migratory salmonids during seaward migration phases (McMichael *et al.* 2004, Moyle and Israel 2005). It is largely accepted, however, that other species impacted by diversions were poorly considered during screen design (Swanson *et al.* 2005b). Therefore, screen criteria are now becoming increasingly developed to accommodate non-salmonid species in an effort and protect other migratory species.

Although screening legislation presently exists in many countries to protect endangered fish, typically these are associated with 'grandfather clauses'. Such clauses make existing diversions exempt from screening requirements and only new diversions over a specified size are legislated to screen. These clauses afford some protection to owners of existing structures and screening requirements are typically not applied unless a major modification is made. Because of similar clauses, screening legislation cannot be applied to a majority of diversions throughout the Pacific Coast in the United States, where diversions are generally small (<5 cfs or 12.2 ML.day⁻¹) and owners are not bound to screen (Kepshire 2000). Similar 'grandfather clauses' currently apply to the provision of fish passage in some states of the Murray-Darling Basin. For instance, under the NSW *Fisheries Management Act, 1994* the Minister may require works to enable fish passage on either new barriers, or existing ones that are being upgraded.

The most effective way of promoting fish screen adoption appears to be through incentives rather than legislation or regulation (Kepshire 2000). In parts of the USA, to encourage voluntary screening, generous financial subsidies of up to 60 % of the total cost of design, engineering and installation are offered in addition to tax concessions (ODFW 2010). So while fish screening laws were passed in Oregon as early as 1898, more recently it has been the legislated cost-share program (begun in 1991) which has seen a rapid and steady uptake of fish screens in the Columbia Basin (Kepshire 2000). Fish screen funding sourced through State Lottery revenue has been used to leverage additional irrigator contributions and improve migratory salmonid protection (ODFW 2010). Irrigator contributions can include in-kind labour or materials which reduce the need for individuals to meet substantial capital costs. The overall success of this approach has seen over 50 % of all irrigation diversions in Oregon (estimated at over 55,000) fitted with screens in the past century (Kepshire 2000).

There may be opportunities to assist irrigators with the installation of fish screens in the Murray-Darling Basin under existing grants programs. As part of the Australian Government's \$5.8 billion Sustainable Rural Water Use and Infrastructure Program under Water for the Future, \$300 million has been made available to assist irrigators upgrade infrastructure with the aim of improving water efficiencies to promote environmental sustainability (DSEWPC 2010). Although fish screening is not currently acknowledged in this On-Farm Irrigation Efficiency Program, it would be feasible for such a program to support capital and installation costs associated with system upgrades and ancillary screening equipment, given the clear benefits associated with reducing impacts on aquatic environments. This requires recognition from government and stakeholders that sustainable water diversion is more than a matter of reducing the amount of water diverted, but also involves diverting it in a manner which has less environmental impact. As exemplified by the Oregon Department of Fish and Wildlife (ODFW) cost-share program, the large commitment that the Australian Commonwealth Government has already made into funding the upgrade of irrigation infrastructure provides a fantastic opportunity to establish a pilot fish screening program in the Basin.

Not all incentives need be of a direct monetary nature. Unscreened diversions not only entrain fish, but also sticks and other debris that can clog irrigation systems thus preventing water flow and increasing infrastructure down time and repair costs. Experience from the Pacific Coast suggests that reducing the running and maintenance costs of infrastructure can be a major motivator for irrigators to

both install and maintain intake screens. Fish protection often becomes a secondary objective but it is still an important consideration (Alan Ritchey, Oregon Fish Screening Coordinator ODFW, personnel communication). There are anecdotal reports that some irrigators around the Narrabri area of the Murray-Darling Basin have been experimenting with intake screens in response to entrained fish such as bony herring *Nematalosa erebi* seizing pumps. This demonstrates that similar motivations may exist in the Murray-Darling Basin and should be encouraged perhaps via extension programs.

The extent of progress that can be made when irrigators champion a cause is exemplified in the Hood River, Oregon. Water users from the Farmers Irrigation District (FID) spent over a decade developing a unique horizontal screening device in conjunction with other agencies and not-for-profit organisations, out of necessity to protect both irrigation infrastructure and fish populations. As a result the FID have patented their Farmers Screen and licensed the technology to the Farmers Conservation Alliance (FCA). The FCA is committed to protecting fish and reducing the maintenance and operation costs of irrigators, by coordinating screening projects and putting the profits back into fish protection and assisting irrigators. Within the Murray-Darling Basin, community groups such as the Murray-Darling Basin Authority's Native Fish Strategy Community Stakeholder Task Force, provides a perfect example of how the protection of fish populations in the Murray-Darling Basin can be promoted in a collaborative manner.

4.6 Co-ordination

Whatever the motivation is for irrigators to screen diversions, it needs to be harnessed and maintained. The best way to achieve this is to give ownership of any program to water users by involving them from the outset. The irrigation sector needs to be actively involved and supportive of screen design and refinement, project prioritisation and consulted on how the program could best operate. Fundamental to this in the State of Oregon has been the establishment of a Fish Screening Taskforce. The Taskforce coordinates the cost share program for the installation of screens at diversions. Appointed by the Oregon Fish and Wildlife Commission, this nine person public body comprises representatives from the agricultural sector, recreational fishermen, the fish conservation sector and the general public. The taskforce is involved in project prioritisation, reviewing most applications to the cost-share program and ensuring that screening rules and design criteria develop in response to the latest research.

It should not be difficult for an analogous Fish Screening Task Force to be established in the Murray-Darling Basin. The Murray-Darling Basin Authority's Native Fish Strategy already utilises such a model in the form of a Fish Passage Taskforce, Community Stakeholder Taskforce and Native Fish Strategy Coordinators. A Fish Screening Taskforce should at least comprise fish biologists, irrigation engineers, irrigators, recreational fishers and conservation managers.

4.7 Maintenance is an important factor of any screening program

Fish screens operate in hostile environments, continually exposed to water, sediment and debris. Interference with screen operation through fouling or damage can substantially reduce optimal function (McMichael *et al.* 2004). Ongoing maintenance is therefore a critical aspect of screen effectiveness (Neitzel *et al.* 1990), often necessitating the development of ongoing monitoring and evaluation programs to ensure maximum screen efficiency, compliance with guidelines and fish protection at times of peak fish migration (McMichael *et al.* 2004, U.S. Department of the Interior 2009). Screen maintenance is seen as one of the biggest challenges faced by screening programs in the Pacific Coast (Alan Ritchey, ODFW, personnel communication) and routine inspection and maintenance is seen as being more cost effective than responding to major maintenance issues when they arise. Any fish screening program in the Murray-Darling Basin will need to establish how ongoing screen maintenance costs will be met, both to gain and maintain irrigator support, but also to ensure screens continue to protect fish.

4.8 Conclusion and recommendations

There is mounting evidence that irrigation diversions are contributing to the loss of fish from rivers in the Murray-Darling Basin and this important conservation issue will need to be addressed if fish population declines are to be addressed. A Basin-wide fish screening program will be the best way to reduce fish losses without compromising the needs of irrigators. Importantly, in developing fish screening programs in the Murray-Darling Basin, there is little need to “reinvent the wheel”, meaning that we have the ability to act swiftly and start addressing this problem with a significant level of confidence. Much can be learnt from the evolution of systematic, well-funded and coordinated screening programs over the last century in the Pacific Coast of the USA. Importantly, key characteristics of these programs have direct relevance to the Murray-Darling Basin.

When developing a fish screening program in the Murray-Darling Basin it is recommended to:

1. Undertake an inventory of the number, types and size of diversions across the Basin to assist with prioritising investment;
2. Acknowledge the science undertaken to date and the likely spatial and temporal variability in the impact of different diversions. Action should not be delayed in favour of further quantifying the number of fish removed at different diversions. A precautionary approach to fisheries management should be adopted, where diversions are presumed to impact on fish unless proven otherwise;
3. Take an evidence based approach to setting screen design criteria specific for Australian species and vulnerable age classes;
4. Utilise the extensive development that has already been undertaken with respect to screening technologies in the USA and only adopt different technologies as a way of accommodating for the diverse range of diversion types that will be encountered;
5. Further investigate the role of incentives and legislation to facilitate cost-share programs to assist with the adoption of screening by irrigators;
6. Establish a Fish Screening Taskforce to coordinate project prioritisation and investment (including cost-sharing programs), the development of screening guidelines and to ensure water users have direct ownership and involvement in developing programs; and
7. Acknowledge that ongoing maintenance of fish screens is essential and can be a financial burden if not incorporated into program budgets from the beginning.

5. CONCLUSION AND FINAL RECOMMENDATIONS

Fish screens can protect fish populations whilst maintaining irrigator entitlements. Given the extensive nature of water diversion in the Murray-Darling Basin and the mounting evidence that a significant numbers of fish and life history stages are vulnerable to extraction from river ecosystems, native fish recovery in the Basin will be hampered without a concerted effort being made to screen fish at water diversions. There are several different screening approaches currently applied in countries like the USA, many of which would be suitable for application in the Murray-Darling Basin, it is essential that technologies be designed for local species. The need to replace many obsolete salmonid-based fishways in the Murray-Darling Basin over the last two decades has demonstrated the risk associated with adopting design criteria developed for non-native species. Only through targeted research programs and by adaptively managing the construction of new fishways has upstream passage been restored for many native species. In a similar way, when adopting overseas designs for fish screens, there is a need to ensure that they operate in a way that is hydraulically favourable for Murray-Darling Basin species.

A combination of field and lab-based experiments was used to test a variety of approach velocities and screening materials for the first time in Australia. The installation of fish screens significantly reduced the rate of entrainment of fish at intakes. Approach velocities (measured 8 cm from the screen) of up to 0.4 m/sec (1.5 m/sec slot velocity through the screen) were effective in reducing entrainment of juvenile golden perch and silver perch in laboratory trials, with very little injury or mortality resulting from incidental screen contacts or impingement. In comparison, field observations of an assemblage of fish at an experimental screen demonstrated that even modest increases in approach velocity (from 0.1 to 0.5 m/sec) produced a significant increase in the rate of screen contact for fish smaller than 150 mm, with the impact being more marked the smaller fish were.

Based on these findings, it is recommended that initial guidelines recommend that approach velocities for Murray-Darling Basin fish screens not exceed 0.1m/sec. This guideline reflects acceptable limits in other parts of the world and there are currently many cost effective screening solutions available to achieve this. The recommendation of 0.1 m/sec is precautionary, since until the potential sub-lethal or lethal impacts of these screen contacts can be understood for a larger range of species and size classes, uncertainty remains as to whether higher approach velocities will provide adequate protection for the entire assemblage of fish. For some species, velocities exceeding 0.1 m/sec may be appropriate. For instance, for perforated plate screen, approach velocities of up to 0.4 m/sec provided adequate protection for juvenile silver perch and golden perch. But if the objective is to devise design criteria that will protect a wide range of species and life history stages from diversion, criteria need to be set to protect the most vulnerable in the population. Further laboratory testing of small-bodied species and a greater range of early life history stages is needed before deciding whether critical velocity thresholds could be set at higher levels.

Perforated plate is a material commonly used in fish screens elsewhere in the world. It is readily available, cost effective and has reliable long-term performance when combined with passive (e.g. sweeping velocities) or active (e.g. brushes) cleaning techniques. We demonstrated that golden perch and silver perch, could easily free themselves after contacting a perforated plate screen over a large range of approach velocities, with little apparent adverse health affects. Research elsewhere in the world indicates little difference in screen contact and subsequent injury rates when fish were exposed to a range of screening materials. Similarly, we found little difference in the rate of screen contact or entrainment at an intake when comparing three different sizes of woven wire mesh (5, 10 and 20 mm). Together this information suggests that screening material may not be as important a consideration when designing screens for the protection of fish, as long as suitable approach velocities are being maintained in front of the screen face. That is, emphasis needs to be given to using a material that is robust enough to ensure that desired approach velocities can be reliably maintained over the long-term in often adverse operating conditions. It is therefore recommended that those installing screens in the

Murray-Darling Basin be guided by principles developed overseas with respect to appropriate screen materials, as these have been well-tested and their performance and limitations well established for a diverse range of screening technologies and environmental settings.

It is important that recommended criteria are adaptively adopted as new information becomes available. Initially, it would be beneficial to undertake the following research:

1. Laboratory trials to investigate the interaction between life history stage/size (larvae through to one year) and increasing approach velocity (ranging between 0.1 and 0.5 m/sec) for Murray cod, trout cod and silver or golden perch. Screen material can be standardised as perforated plate, with the rate of screen contact and impingement and fish injury and mortality being the dependent variables quantified.
2. Laboratory trials to investigate the impact of increasing approach velocity (again ranging between 0.1 and 0.5 m/sec) on the rate of screen contact and impingement and fish injury and mortality for small bodied species (e.g. Australian smelt, carp gudgeon and Murray-Darling rainbowfish).
3. A literature review into the applicability of larval fish screens in the Murray-Darling Basin and experimentation into the effectiveness of self cleaning rotating pump screens for reducing mortality of egg and larval life history stages.
4. A Before-After-Control-Impact (BACI) study testing the effectiveness of installing a fish screen of the specifications outlined in this report (e.g. perforated plate 0.1 m/sec approach velocity) on an irrigation diversion in the field. This should utilise DIDSON to enable fish behaviour at the screen face to be effectively quantified.

A century after fish screens were first installed to protect migrating salmonids in the Pacific Coast of the USA, research aimed at refining screen design is still ongoing using an evidence-based approach. Successful screening programs were reviewed and used to determine actions likely to facilitate large-scale fish screening in the Murray-Darling Basin. Fish screening coordinating committees are a key factor to successes in the USA and should be established to provide guidance regarding the setting and refinement of screen design criteria, to prioritise projects for implementation, to identify funding opportunities and assist in the development of incentive schemes. Committees need to engage community members, particularly irrigators, to support the program. Individual Catchment Management Authorities can be involved at a local level by developing diversion management plans. State and federal agencies could support local irrigators and screening initiatives through legislative and policy support.

Given that no screen design criteria currently exist for Australian native fish, appropriate guidelines should be developed as soon as possible. Guidelines from other countries can help inform screen material, positioning, maintenance and performance standards. Approach velocity will need to be a feature of primary consideration when developing new guidelines for the Murray-Darling Basin. It is clear that approach velocities will be needed to protect vulnerable species and that an ongoing field and laboratory-based research program will be needed to adaptively inform further screen design development. Diversion management plans for all catchments in the Murray-Darling Basin, backed by adaptively implemented guidelines will provide a robust framework to arrest further native fish declines.

6. REFERENCES

- Allen, D. H. (1975). *Loss of striped bass eggs and young through small agricultural diversions in Sacramento-San Joaquin Delta*. No. 75-3. Californian Department of Fish and Game, Anadromous Fisheries Branch, Sacramento, 11 pp.
- Anderson, M. J., Gorley, R. N. and Clarke, K. R. (2008) *PERMANOVA+ for PRIMER: Guide to software and statistical methods*. PRIMER-E, Plymouth, UK.
- Anon (1997). *Fish Screening Criteria for Anadromous Salmonids*. National Marine Fisheries Service, Santa Rosa, 10pp pp.
- Bams (1967). Differences in performance of naturally and artificially propagated sockeye salmon migrant fry, as measured with swimming and predation tests. *Journal of the Fisheries Research Board of Canada* **24**: 17-53.
- Barrett, J., Baumgartner, L. J., Boys, C. A., Mallen-Cooper, M., Stuart, I. G. and Zampatti, B. P. (2008). The need for fish passage in the Murray-Darling Basin. In: J. Barrett (ed.). *The sea to Hume Dam: Restoring fish passage in the Murray River*. Murray-Darling Basin Commission, Canberra, 1-11 pp.
- Baumgartner, L., Reynoldson, N., Cameron, L. and Stanger, J. (2007). *The effects of selected irrigation practices on fish of the Murray-Darling Basin*. Fisheries Final Report Series. NSW Department of Primary Industries, Cronulla, 90 pp.
- Baumgartner, L. J., Reynoldson, N., Cameron, L. and Stanger, J. (2006). *Assessment of a Dual-frequency Identification Sonar (DIDSON) for application in fish migration studies*. Fisheries Final Report Series No. 84. NSW Department of Primary Industries, Cronulla, 37 pp.
- Baumgartner, L. J., Reynoldson, N. K., Cameron, L. and Stanger, J. G. (2009). Effects of irrigation pumps on riverine fish. *Fisheries Management and Ecology* **16**: 429-437.
- Belcher, E. O., Dinh, H. Q., Lynn, D. C. and Laughlin, T. J. (1999). Beamforming and imaging with acoustic lenses in small, high-frequency sonars. *MTS/IEEE* **3**: 1495-1499.

- Boswell, K. M., Wilson, M. P. and Cowan, J. H. (2008). A semiautomated approach to estimating fish size, abundance, and behavior from dual-frequency identification sonar (DIDSON) data. *North American Journal of Fisheries Management* **28**: 799-807.
- Brannon, E. S. (1929). *Yakima Basin ditch screen report*. Washington Department of Fisheries, Olympia, WA.
- CDFG (2000). *Fish Screen Criteria*. Californian Department of Fish and Game, Sacramento.
- Cech, J. J. M. and Mussen, T. (2006). *Determining how fish detect fish screens and testing potential fish screen enhancements*. California Energy Commission, PIER Energy-Related Environmental Research Program. CEC-500-2006-117, 32 pp.
- Crabb, P. (1997) *Murray-Darling Basin Resources*. Murray-Darling Basin Commission, Canberra. 300 pp.
- Danley, M. L., Mayr, S. D., Young, P. S. and Cech, J. J. (2002). Swimming performance and physiological stress responses of splittail exposed to a fish screen. *North American Journal of Fisheries Management* **22**: 1241-1249.
- Dayton, P. K. (1989). Reversal of the burden of proof in fisheries management. *Science* **279**: 821-822.
- Downes, B. J., Barmuta, L. A., Fairweather, P. G., Faith, D. P., Keough, M. J., Lake, P. S., Mapstone, B. D. and Quinn, G. P. (2002) *Monitoring ecological impacts: concepts and practice in flowing waters*. Cambridge University Press, Cambridge. 434 pp.
- DSEWPC (2010). *Sustainable Rural Water Use and Infrastructure Program*. Department of Sustainability, Environment, Water, Population and Communities, Canberra (<http://www.environment.gov.au/water/publications/policy-programs/pubs/srwui-program-factsheet.pdf> last verified 8/8/11).
- Dudgeon, D., Arthington, A. H., Gessner, M. O., Kawabata, Z. I., Knowler, D. J., Lévêque, C., Naiman, R. J., Prieur-Richard, A. H., Soto, D. and Stiassny, M. L. J. (2006).

- Freshwater biodiversity: importance, threats, status and conservation challenges. *Biological Reviews* **81**: 163-182.
- Gilligan, D. M. and Schiller, C. B. (2003). *Downstream transport of larval and juvenile fish in the Murray River*. NSW Fisheries Final Report Series No. 50. NSW Fisheries, Cronulla, 66 pp.
- Higginbottom, I., Woon, S. and Schneider, P. (2008). *Hydroacoustic data processing for standard stock assessment using Echoview. Technical manual*. Myriax Software Pty Ltd, Australia, 139 pp.
- Humphries, P. and Lake, P. S. (2000). Fish larvae and the management of regulated rivers. *Regulated Rivers: Research and Management* **16**: 421-432.
- Humphries, P., Serafini, L. G. and King, A. J. (2002). River regulation and fish larvae: variation through space and time. *Freshwater Biology* **47**: 1307-1331.
- Humphries, P. and King, A. J. (2004). Drifting fish larvae in Murray-Darling Basin rivers: Compositions, spatial and temporal patterns and distance drifted. In: M. Lintermans and B. Phillips (eds.). *Downstream Movement of Fish in the Murray-Darling Basin. Statements, recommendations and supporting papers from a workshop held in Canberra, 3-4 June 2003*. Murray-Darling Basin Commission, Canberra, 51-58 pp.
- Intake Screens Inc. (2010). Brushed cylinder for submerged intakes. <http://intakescreensinc.com/brushed-cylinder/> (last verified 8/3/2012).
- Jamieson, D., Bonnett, M., Jellyman, D. and Unwin, M. (2005). *Fish Screening: good practice guidelines for Canterbury*. NIWA, Auckland, 70pp pp.
- Jones, D. R., Kiceniuk, J. W. and Bamford, O. S. (1974). Evaluation of the swimming performance of several fish species from the Mackenzie River. *Journal of the Fisheries Research Board of Canada* **31**: 1641-1647.
- Kepshire, B. (2000). Oregon Department of Fish and Wildlife Fish Screening Program: Fish Screen Types and Costs. In: *Proceedings of the Salmon Habitat Restoration Cost Workshop*. Gladstone, Oregon, S. T. Allen, C. Thomson and R. Carlson (eds). Pacific States Marine Fisheries Commission, 276pp.

- King, A. J. and O'Connor, J. P. (2007). Native fish entrapment in irrigation systems: A step towards understanding the significance of the problem. *Ecological Management & Restoration* **8**: 32-37.
- King, A. J. and O'Connor, J. P. (2007). Native fish entrapment in irrigation systems: a step towards understanding the significance of the problem. *Ecological Management & Restoration* **8**: 32-37.
- Kingsford, R. T. (2000). Ecological impacts of dams, water diversions and river management on floodplain wetlands in Australia. *Austral Ecology* **25**: 109-127.
- Larinier, M. (2008). Fish passage experience at small-scale hydro-electric power plants in France. *Hydrobiologia* **609**: 97-108.
- Lintermans, M. and Phillips, B. (eds) (2004) *Downstream movement of fish in the Murray-Darling Basin - workshop held in Canberra, 3-4 June 2003: Statement, recommendations and supporting papers*. Murray-Darling Basin Commission, Canberra.
- Lintermans, M. (2007) *Fishes of the Murray-Darling Basin: An introductory guide*. Murray-Darling Basin Commission, Canberra.
- Mallen-Cooper, M. (1992). Swimming ability of juvenile Australian bass, *Macquaria novemaculeata* (Steindachner), and juvenile barramundi, *Lates calcarifer* (Bloch), in an experimental vertical-slot fishway. *Marine and Freshwater Research* **43**: 823-833.
- Mallen-Cooper, M. (1994). Swimming ability of adult golden perch, *Macquaria ambigua* (Percichthyidae), and adult silver perch, *Bidyanus bidyanus* (Teraponidae), in an experimental vertical-slot fishway. *Marine and Freshwater Research* **45**: 191-198.
- Mallen-Cooper, M. (1999). Developing fishways for non-salmonid fishes; a case study from the Murray River in Australia. In: M. Odeh (ed.). *Innovations in Fish Passage Technology*. American Fisheries Society, Bethesda, 173-195 pp.

- Mallen-Cooper, M. and Brand, D. (2007). Non-salmonids in a salmonid fishway: what do 50 years of data tell us about past and future fish passage? *Fisheries Management and Ecology* **14**: 319-332.
- McMichael, G. A., Vucelick, J. A., Abernethy, C. S. and Neitzel, D. A. (2004). Comparing fish screen performance to physical design criteria. *Fisheries* **29**: 10-16.
- MDBA (2010). *Guide to the proposed Basin Plan: overview*. Murray-Darling Basin Authority, Canberra, 223 pp.
- MDBC (1995). *An audit of water use in the Murray-Darling Basin*. Murray-Darling Basin Ministerial Advisory Council, Canberra.
- MDBC (2008). *Native Fish Strategy. 2006-2007 Annual Implementation Report*. Murray-Darling Basin Commission, Canberra, 52 pp.
- Moursund, R. A., Carlson, T. J. and Peters, R. D. (2003). A fisheries application of a dual-frequency identification sonar acoustic camera. *ICES Journal of Marine Science* **60**: 678-683.
- Moyle, P. B. and Williams, J. E. (1990). Biodiversity loss in the temperate zone: decline of the native fish fauna of California. *Conservation Biology* **4**: 275-284.
- Moyle, P. B. and Israel, J. A. (2005). Untested assumptions: Effectiveness of screening diversions for conservation of fish populations. *Fisheries* **30**: 20-28.
- Musick, J., Harbin, M., Berkeley, S., Burgess, G., Eklund, A., Findley, L., Gilmore, R., Golden, J., Ha, D. and Huntsman, G. (2000). Marine, estuarine, and diadromous fish stocks at risk of extinction in North America (exclusive of Pacific salmonids). *Fisheries* **25**: 6-30.
- Neitzel, D. A., Abernethy, C. S. and Martenson, G. A. (1990). *A fisheries evaluation of the westside ditch and town cala fish screening facilities*. Pacific Northwest National Laboratory, Richland, 54pp pp.

- NMFS (1997). *Juvenile Fish Screen Criteria for Anadromous Salmonids*. National Marine Fisheries Service, Portland, Oregon (<http://swr.nmfs.noaa.gov/hcd/fishscrn.pdf> last verified 5/8/11), 10 pp.
- Nordlund, B. and Bates, K. (2000). *Fish protection screen guidelines for Washington State*. Washington Department of Fish and Wildlife, Seattle, 53pp pp.
- ODFW (2009). *ODFW Backgrounder: Fish Screen Program*. Oregon Department of Fish and Wildlife, Salem.
- ODFW (2010). *Fish Screening Program. Economic Incentives for Water Users to Protect Fish. 2007-2009 Report to the Legislature*. Oregon Department of fish and Wildlife, Salem, Oregon (<http://library.state.or.us/repository/2011/201104081048295/2007-09.pdf> last verified 8/8/2011), 33 pp.
- Peake, S. (2004). Effect of approach velocity on impingement of juvenile northern pike at water intake screens. *North American Journal of Fisheries Management* **24**: 390-396.
- Prince, E. E. (1923). Irrigation canals as an aid to fisheries development in the West. *Transactions of the American Fisheries Society* **52**: 157-165.
- Rose, B. P., Mesa, M. G. and Barbin-Zydlowski, G. (2008). Field-based evaluations of horizontal flat-plate fish screens. *North American Journal of Fisheries Management* **28**: 1702-1713.
- Sound Metrics (2009). *Dual-Frequency Identification Sonar DIDSON Software Manual V5.24*. Sound Metrics Corporation, Botwell Park, NE, 77 pp.
- Spaar, S. (1994). Delta agricultural diversion evaluation 1992 pilot study. Interagency Ecological Program for the San Francisco Bay. *Delta Estuary Technical Report* **37**: 37.
- Swanson, C. and Young, P. (1998). Swimming performance of delta smelt: maximum performance, and behavioral and kinematic limitations on swimming at submaximal velocities. *Journal of Experimental Biology* **201**: 333.

- Swanson, C., Young, P. S. and Cech, J. J. (2004). Swimming in two-vector flows: performance and behavior of juvenile chinook salmon near a simulated screened water diversion. *Transactions of the American Fisheries Society* **133**: 265-278.
- Swanson, C., Young, P. S. and Cech, J. J. (2005a). Close encounters with a fish screen: Integrating physiological and behavioral results to protect endangered species in exploited ecosystems. *Transactions of the American Fisheries Society* **134**: 1111-1123.
- Swanson, C., Young, P. S. and Cech, J. J. (2005b). Close encounters with a fish screen : Integrating physiological and behavioral results to protect endangered species in exploited ecosystems. *Transactions of the American Fisheries Society* **134**: 1111-1123.
- Taylor, E. B. and McPhail, J. D. (1985). Variation in burst and prolonged swimming performance among British Columbia populations of coho salmon, *Oncorhynchus kisutch*. *Canadian Journal of Fisheries and Aquatic Sciences* **42**: 2029-2033.
- Thoms, M. C., Maher, S., Terrill, P., Crab, P., Harris, J. and Sheldon, F. (2004). Environmental Flows in the Darling River. In: R. Breckwoldt, R. Boden and J. Andrew (eds.). The Murray-Darling Basin Commission, Canberra, 350-373 pp.
- Tiffan, K. F., Rondorf, D. W. and Skalicky, J. J. (2004). Imaging fall Chinook salmon redds in the Columbia River with a dual-frequency identification sonar. *North American Journal of Fisheries Management* **24**: 1421-1426.
- Turnpenny, W. H., Struthers, G. and Hanson, K. P. (1998) *A UK guide to intake fish-screening regulations: Policy and Best Practice*. Fawley Laboratories, London.
- U.S. Department of the Interior (2006). *Fish protection at water diversions - A guide for planning and designing fish exclusion facilities*. Water Resources Technical Publication. U.S. Department of the Interior Bureau of Reclamation, Denver, Colorado, 480 pp.
- U.S. Department of the Interior (2009). *Guidelines for performing hydraulic field evaluations at fish screening facilities*. Water Resources Technical Publication. U.S. Department of the Interior Bureau of Reclamation, Denver, Colorado, 48 pp.

- Vörösmarty, C. J., Green, P., Salisbury, J. and Lammers, R. B. (2000). Global water resources : vulnerability from climate change and population growth. *Science* **289**: 284-288.
- Walker, K. (1985). A review of the ecological effects of river regulation in Australia. *Hydrobiologia* **125**: 111-129.
- White, D. K., Swanson, C., Young, P. S., Cech, J. J., Chen, Z. Q. and Kavvas, M. L. (2007). Close encounters with a fish screen II: Delta smelt behavior before and during screen contact. *Transactions of the American Fisheries Society* **136**: 528-538.
- Young, P. S., Swanson, C. and Cech, J. J. (2010). Close encounters with a fish screen III: behavior, performance, physiological stress responses, and recovery of adult delta smelt exposed to two-vector flows near a fish screen. *Transactions of the American Fisheries Society* **139**: 713-726.
- Zydlewski, G. B. and Johnson, J. R. (2002). Response of bull trout fry to four types of water diversion screens. *North American Journal of Fisheries Management* **22**: 1276-1282.

Other titles in this series:**ISSN 1440-3544 (NSW Fisheries Final Report Series)**

- No. 1 Andrew, N.L., Graham, K.J., Hodgson, K.E. and Gordon, G.N.G., 1998. Changes after 20 years in relative abundance and size composition of commercial fishes caught during fishery independent surveys on SEF trawl grounds.
- No. 2 Virgona, J.L., Deguara, K.L., Sullings, D.J., Halliday, I. and Kelly, K., 1998. Assessment of the stocks of sea mullet in New South Wales and Queensland waters.
- No. 3 Stewart, J., Ferrell, D.J. and Andrew, N.L., 1998. Ageing Yellowtail (*Trachurus novaezelandiae*) and Blue Mackerel (*Scomber australasicus*) in New South Wales.
- No. 4 Pethebridge, R., Lugg, A. and Harris, J., 1998. Obstructions to fish passage in New South Wales South Coast streams. 70pp.
- No. 5 Kennelly, S.J. and Broadhurst, M.K., 1998. Development of by-catch reducing prawn-trawls and fishing practices in NSW's prawn-trawl fisheries (and incorporating an assessment of the effect of increasing mesh size in fish trawl gear). 18pp + appendices.
- No. 6 Allan, G.L. and Rowland, S.J., 1998. Fish meal replacement in aquaculture feeds for silver perch. 237pp + appendices.
- No. 7 Allan, G.L., 1998. Fish meal replacement in aquaculture feeds: subprogram administration. 54pp + appendices.
- No. 8 Heasman, M.P., O'Connor, W.A. and O'Connor, S.J., 1998. Enhancement and farming of scallops in NSW using hatchery produced seedstock. 146pp.
- No. 9 Nell, J.A., McMahon, G.A. and Hand, R.E., 1998. Tetraploidy induction in Sydney rock oysters. 25pp.
- No. 10 Nell, J.A. and Maguire, G.B., 1998. Commercialisation of triploid Sydney rock and Pacific oysters. Part 1: Sydney rock oysters. 122pp.
- No. 11 Watford, F.A. and Williams, R.J., 1998. Inventory of estuarine vegetation in Botany Bay, with special reference to changes in the distribution of seagrass. 51pp.
- No. 12 Andrew, N.L., Worthington D.G., Brett, P.A. and Bentley N., 1998. Interactions between the abalone fishery and sea urchins in New South Wales.
- No. 13 Jackson, K.L. and Ogburn, D.M., 1999. Review of depuration and its role in shellfish quality assurance. 77pp.
- No. 14 Fielder, D.S., Bardsley, W.J. and Allan, G.L., 1999. Enhancement of Mulloway (*Argyrosomus japonicus*) in intermittently opening lagoons. 50pp + appendices.
- No. 15 Otway, N.M. and Macbeth, W.G., 1999. The physical effects of hauling on seagrass beds. 86pp.
- No. 16 Gibbs, P., McVea, T. and Loudon, B., 1999. Utilisation of restored wetlands by fish and invertebrates. 142pp.
- No. 17 Ogburn, D. and Ruello, N., 1999. Waterproof labelling and identification systems suitable for shellfish and other seafood and aquaculture products. Whose oyster is that? 50pp.
- No. 18 Gray, C.A., Pease, B.C., Stringfellow, S.L., Raines, L.P. and Walford, T.R., 2000. Sampling estuarine fish species for stock assessment. Includes appendices by D.J. Ferrell, B.C. Pease, T.R. Walford, G.N.G. Gordon, C.A. Gray and G.W. Liggins. 194pp.
- No. 19 Otway, N.M. and Parker, P.C., 2000. The biology, ecology, distribution, abundance and identification of marine protected areas for the conservation of threatened Grey Nurse Sharks in south east Australian waters. 101pp.
- No. 20 Allan, G.L. and Rowland, S.J., 2000. Consumer sensory evaluation of silver perch cultured in ponds on meat meal based diets. 21pp + appendices.
- No. 21 Kennelly, S.J. and Scandol, J. P., 2000. Relative abundances of spanner crabs and the development of a population model for managing the NSW spanner crab fishery. 43pp + appendices.
- No. 22 Williams, R.J., Watford, F.A. and Balashov, V., 2000. Kooragang Wetland Rehabilitation Project: History of changes to estuarine wetlands of the lower Hunter River. 82pp.
- No. 23 Survey Development Working Group, 2000. Development of the National Recreational and Indigenous Fishing Survey. Final Report to Fisheries Research and Development Corporation. (Volume 1 – 36pp + Volume 2 – attachments).
- No.24 Rowling, K.R and Raines, L.P., 2000. Description of the biology and an assessment of the fishery of Silver Trevally *Pseudocaranx dentex* off New South Wales. 69pp.

- No. 25 Allan, G.L., Jantrarotai, W., Rowland, S., Kosuturak, P. and Booth, M., 2000. Replacing fishmeal in aquaculture diets. 13pp.
- No. 26 Gehrke, P.C., Gilligan, D.M. and Barwick, M., 2001. Fish communities and migration in the Shoalhaven River – Before construction of a fishway. 126pp.
- No. 27 Rowling, K.R. and Makin, D.L., 2001. Monitoring of the fishery for Gemfish *Rexea solandri*, 1996 to 2000. 44pp.
- No. 28 Otway, N.M., 1999. Identification of candidate sites for declaration of aquatic reserves for the conservation of rocky intertidal communities in the Hawkesbury Shelf and Batemans Shelf Bioregions. 88pp.
- No. 29 Heasman, M.P., Goard, L., Diemar, J. and Callinan, R., 2000. Improved Early Survival of Molluscs: Sydney Rock Oyster (*Saccostrea glomerata*). 63pp.
- No. 30 Allan, G.L., Dignam, A and Fielder, S., 2001. Developing Commercial Inland Saline Aquaculture in Australia: Part 1. R&D Plan.
- No. 31 Allan, G.L., Banens, B. and Fielder, S., 2001. Developing Commercial Inland Saline Aquaculture in Australia: Part 2. Resource Inventory and Assessment. 33pp.
- No. 32 Bruce, A., Grouns, I. and Gehrke, P., 2001. Woronora River Macquarie Perch Survey. 116pp.
- No. 33 Morris, S.A., Pollard, D.A., Gehrke, P.C. and Pogonoski, J.J., 2001. Threatened and Potentially Threatened Freshwater Fishes of Coastal New South Wales and the Murray-Darling Basin. 177pp.
- No. 34 Heasman, M.P., Sushames, T.M., Diemar, J.A., O'Connor, W.A. and Foulkes, L.A., 2001. Production of Micro-algal Concentrates for Aquaculture Part 2: Development and Evaluation of Harvesting, Preservation, Storage and Feeding Technology. 150pp + appendices.
- No. 35 Stewart, J. and Ferrell, D.J., 2001. Mesh selectivity in the NSW demersal trap fishery. 86pp.
- No. 36 Stewart, J., Ferrell, D.J., van der Walt, B., Johnson, D. and Lowry, M., 2001. Assessment of length and age composition of commercial kingfish landings. 49pp.
- No. 37 Gray, C.A. and Kennelly, S.J., 2001. Development of discard-reducing gears and practices in the estuarine prawn and fish haul fisheries of NSW. 151pp.
- No. 38 Murphy, J.J., Lowry, M.B., Henry, G.W. and Chapman, D., 2002. The Gamefish Tournament Monitoring Program – 1993 to 2000. 93pp.
- No. 39 Kennelly, S.J. and McVea, T.A. (Ed), 2002. Scientific reports on the recovery of the Richmond and Macleay Rivers following fish kills in February and March 2001. 325pp.
- No. 40 Pollard, D.A. and Pethebridge, R.L., 2002. Report on Port of Botany Bay Introduced Marine Pest Species Survey. 69pp.
- No. 41 Pollard, D.A. and Pethebridge, R.L., 2002. Report on Port Kembla Introduced Marine Pest Species Survey. 72pp.
- No. 42 O'Connor, W.A, Lawler, N.F. and Heasman, M.P., 2003. Trial farming the akoya pearl oyster, *Pinctada imbricata*, in Port Stephens, NSW. 170pp.
- No. 43 Fielder, D.S. and Allan, G.L., 2003. Improving fingerling production and evaluating inland saline water culture of snapper, *Pagrus auratus*. 62pp.
- No. 44 Astles, K.L., Winstanley, R.K., Harris, J.H. and Gehrke, P.C., 2003. Experimental study of the effects of cold water pollution on native fish. 55pp.
- No. 45 Gilligan, D.M., Harris, J.H. and Mallen-Cooper, M., 2003. Monitoring changes in the Crawford River fish community following replacement of an effective fishway with a vertical-slot fishway design: Results of an eight year monitoring program. 80pp.
- No. 46 Pollard, D.A. and Rankin, B.K., 2003. Port of Eden Introduced Marine Pest Species Survey. 67pp.
- No. 47 Otway, N.M., Burke, A.L., Morrison, N.S. and Parker, P.C., 2003. Monitoring and identification of NSW Critical Habitat Sites for conservation of Grey Nurse Sharks. 62pp.
- No. 48 Henry, G.W. and Lyle, J.M. (Ed), 2003. The National Recreational and Indigenous Fishing Survey. 188 pp.
- No. 49 Nell, J.A., 2003. Selective breeding for disease resistance and fast growth in Sydney rock oysters. 44pp. (Also available – a CD-Rom published in March 2004 containing a collection of selected manuscripts published over the last decade in peer-reviewed journals).
- No. 50 Gilligan, D. and Schiller, S., 2003. Downstream transport of larval and juvenile fish. 66pp.
- No. 51 Liggins, G.W., Scandol, J.P. and Kennelly, S.J., 2003. Recruitment of Population Dynamacist. 44pp.

- No. 52 Steffe, A.S. and Chapman, J.P., 2003. A survey of daytime recreational fishing during the annual period, March 1999 to February 2000, in Lake Macquarie, New South Wales. 124pp.
- No. 53 Barker, D. and Otway, N., 2003. Environmental assessment of zinc coated wire mesh sea cages in Botany Bay NSW. 36pp.
- No. 54 Growsns, I., Astles, A. and Gehrke, P., 2003. Spatial and temporal variation in composition of riverine fish communities. 24pp.
- No. 55 Gray, C. A., Johnson, D.D., Young, D.J. and Broadhurst, M. K., 2003. Bycatch assessment of the Estuarine Commercial Gill Net Fishery in NSW. 58pp.
- No. 56 Worthington, D.G. and Blount, C., 2003. Research to develop and manage the sea urchin fisheries of NSW and eastern Victoria. 182pp.
- No. 57 Baumgartner, L.J., 2003. Fish passage through a Deelder lock on the Murrumbidgee River, Australia. 34pp.
- No. 58 Allan, G.L., Booth, M.A., David A.J. Stone, D.A.J. and Anderson, A.J., 2004. Aquaculture Diet Development Subprogram: Ingredient Evaluation. 171pp.
- No. 59 Smith, D.M., Allan, G.L. and Booth, M.A., 2004. Aquaculture Diet Development Subprogram: Nutrient Requirements of Aquaculture Species. 220pp.
- No. 60 Barlow, C.G., Allan, G.L., Williams, K.C., Rowland, S.J. and Smith, D.M., 2004. Aquaculture Diet Development Subprogram: Diet Validation and Feeding Strategies. 197pp.
- No. 61 Heasman, M.H., 2004. Sydney Rock Oyster Hatchery Workshop 8 – 9 August 2002, Port Stephens, NSW. 115pp.
- No. 62 Heasman, M., Chick, R., Savva, N., Worthington, D., Brand, C., Gibson, P. and Diemar, J., 2004. Enhancement of populations of abalone in NSW using hatchery-produced seed. 269pp.
- No. 63 Otway, N.M. and Burke, A.L., 2004. Mark-recapture population estimate and movements of Grey Nurse Sharks. 53pp.
- No. 64 Creese, R.G., Davis, A.R. and Glasby, T.M., 2004. Eradicating and preventing the spread of the invasive alga *Caulerpa taxifolia* in NSW. 110pp.
- No. 65 Baumgartner, L.J., 2004. The effects of Balranald Weir on spatial and temporal distributions of lower Murrumbidgee River fish assemblages. 30pp.
- No. 66 Heasman, M., Diggles, B.K., Hurwood, D., Mather, P., Pirozzi, I. and Dworjanyn, S., 2004. Paving the way for continued rapid development of the flat (angasi) oyster (*Ostrea angasi*) farming in New South Wales. 40pp.

ISSN 1449-9967 (NSW Department of Primary Industries – Fisheries Final Report Series)

- No. 67 Kroon, F.J., Bruce, A.M., Housefield, G.P. and Creese, R.G., 2004. Coastal floodplain management in eastern Australia: barriers to fish and invertebrate recruitment in acid sulphate soil catchments. 212pp.
- No. 68 Walsh, S., Copeland, C. and Westlake, M., 2004. Major fish kills in the northern rivers of NSW in 2001: Causes, Impacts & Responses. 55pp.
- No. 69 Pease, B.C. (Ed), 2004. Description of the biology and an assessment of the fishery for adult longfinned eels in NSW. 168pp.
- No. 70 West, G., Williams, R.J. and Laird, R., 2004. Distribution of estuarine vegetation in the Parramatta River and Sydney Harbour, 2000. 37pp.
- No. 71 Broadhurst, M.K., Macbeth, W.G. and Wooden, M.E.L., 2005. Reducing the discarding of small prawns in NSW's commercial and recreational prawn fisheries. 202pp.
- No. 72. Graham, K.J., Lowry, M.B. and Walford, T.R., 2005. Carp in NSW: Assessment of distribution, fishery and fishing methods. 88pp.
- No. 73 Stewart, J., Hughes, J.M., Gray, C.A. and Walsh, C., 2005. Life history, reproductive biology, habitat use and fishery status of eastern sea garfish (*Hyporhamphus australis*) and river garfish (*H. regularis ardelio*) in NSW waters. 180pp.
- No. 74 Growsns, I. and Gehrke, P., 2005. Integrated Monitoring of Environmental Flows: Assessment of predictive modelling for river flows and fish. 33pp.
- No. 75 Gilligan, D., 2005. Fish communities of the Murrumbidgee catchment: Status and trends. 138pp.
- No. 76 Ferrell, D.J., 2005. Biological information for appropriate management of endemic fish species at Lord Howe Island. 18 pp.
- No. 77 Gilligan, D., Gehrke, P. and Schiller, C., 2005. Testing methods and ecological consequences of large-scale removal of common carp. 46pp.

- No. 78 Boys, C.A., Esslemont, G. and Thoms, M.C., 2005. Fish habitat and protection in the Barwon-Darling and Paroo Rivers. 118pp.
- No. 79 Steffe, A.S., Murphy, J.J., Chapman, D.J. and Gray, C.C., 2005. An assessment of changes in the daytime recreational fishery of Lake Macquarie following the establishment of a 'Recreational Fishing Haven'. 103pp.
- No. 80 Gannassin, C. and Gibbs, P., 2005. Broad-Scale Interactions Between Fishing and Mammals, Reptiles and Birds in NSW Marine Waters. 171pp.
- No. 81 Steffe, A.S., Murphy, J.J., Chapman, D.J., Barrett, G.P. and Gray, C.A., 2005. An assessment of changes in the daytime, boat-based, recreational fishery of the Tuross Lake estuary following the establishment of a 'Recreational Fishing Haven'. 70pp.
- No. 82 Silberschnieder, V. and Gray, C.A., 2005. Arresting the decline of the commercial and recreational fisheries for mulloway (*Argyrosomus japonicus*). 71pp.
- No. 83 Gilligan, D., 2005. Fish communities of the Lower Murray-Darling catchment: Status and trends. 106pp.
- No. 84 Baumgartner, L.J., Reynoldson, N., Cameron, L. and Stanger, J., 2006. Assessment of a Dual-frequency Identification Sonar (DIDSON) for application in fish migration studies. 33pp.
- No. 85 Park, T., 2006. FishCare Volunteer Program Angling Survey: Summary of data collected and recommendations. 41pp.
- No. 86 Baumgartner, T., 2006. A preliminary assessment of fish passage through a Denil fishway on the Edward River, Australia. 23pp.
- No. 87 Stewart, J., 2007. Observer study in the Estuary General sea garfish haul net fishery in NSW. 23pp.
- No. 88 Faragher, R.A., Pogonoski, J.J., Cameron, L., Baumgartner, L. and van der Walt, B., 2007. Assessment of a stocking program: Findings and recommendations for the Snowy Lakes Trout Strategy. 46pp.
- No. 89 Gilligan, D., Rolls, R., Merrick, J., Lintermans, M., Duncan, P. and Kohen, J., 2007. Scoping knowledge requirements for Murray crayfish (*Euastacus armatus*). Final report to the Murray Darling Basin Commission for Project No. 05/1066 NSW 103pp.
- No. 90 Kelleway, J., Williams, R.J. and Allen, C.B., 2007. An assessment of the saltmarsh of the Parramatta River and Sydney Harbour. 100pp.
- No. 91 Williams, R.J. and Thiebaud, I., 2007. An analysis of changes to aquatic habitats and adjacent land-use in the downstream portion of the Hawkesbury Nepean River over the past sixty years. 97pp.
- No. 92 Baumgartner, L., Reynoldson, N., Cameron, L. and Stanger, J. The effects of selected irrigation practices on fish of the Murray-Darling Basin. 90pp.
- No. 93 Rowland, S.J., Landos, M., Callinan, R.B., Allan, G.L., Read, P., Mifsud, C., Nixon, M., Boyd, P. and Tally, P., 2007. Development of a health management strategy for the Silver Perch Aquaculture Industry. 219pp.
- No. 94 Park, T., 2007. NSW Gamefish Tournament Monitoring – Angling Research Monitoring Program. Final report to the NSW Recreational Fishing Trust. 142pp.
- No. 95 Heasman, M.P., Liu, W., Goodsell, P.J., Hurwood D.A. and Allan, G.L., 2007. Development and delivery of technology for production, enhancement and aquaculture of blacklip abalone (*Haliotis rubra*) in New South Wales. 226pp.
- No. 96 Ganassin, C. and Gibbs, P.J., 2007. A review of seagrass planting as a means of habitat compensation following loss of seagrass meadow. 41pp.
- No. 97 Stewart, J. and Hughes, J., 2008. Determining appropriate harvest size at harvest for species shared by the commercial trap and recreational fisheries in New South Wales. 282pp.
- No. 98 West, G. and Williams, R.J., 2008. A preliminary assessment of the historical, current and future cover of seagrass in the estuary of the Parramatta River. 61pp.
- No. 99 Williams, D.L. and Scandol, J.P., 2008. Review of NSW recreational fishing tournament-based monitoring methods and datasets. 83pp.
- No. 100 Allan, G.L., Heasman, H. and Bennison, S., 2008. Development of industrial-scale inland saline aquaculture: Coordination and communication of R&D in Australia. 245pp.
- No. 101 Gray, C.A and Barnes, L.M., 2008. Reproduction and growth of dusky flathead (*Platycephalus fuscus*) in NSW estuaries. 26pp.

- No. 102 Graham, K.J., 2008. The Sydney inshore trawl-whiting fishery: codend selectivity and fishery characteristics. 153pp.
- No. 103 Macbeth, W.G., Johnson, D.D. and Gray, C.A., 2008. Assessment of a 35-mm square-mesh codend and composite square-mesh panel configuration in the ocean prawn-trawl fishery of northern New South Wales. 104pp.
- No. 104 O'Connor, W.A., Dove, M. and Finn, B., 2008. Sydney rock oysters: Overcoming constraints to commercial scale hatchery and nursery production. 119pp.
- No. 105 Glasby, T.M. and Lobb, K., 2008. Assessing the likelihoods of marine pest introductions in Sydney estuaries: A transport vector approach. 84pp.
- No. 106 Rotherham, D., Gray, C.A., Underwood, A.J., Chapman, M.G. and Johnson, D.D., 2008. Developing fishery-independent surveys for the adaptive management of NSW's estuarine fisheries. 135pp.
- No. 107 Broadhurst, M., 2008. Maximising the survival of bycatch discarded from commercial estuarine fishing gears in NSW. 192pp.
- No. 108 Gilligan, D., McLean, A. and Lugg, A., 2009. Murray Wetlands and Water Recovery Initiatives: Rapid assessment of fisheries values of wetlands prioritised for water recovery. 69pp.
- No. 109 Williams, R.J. and Thiebaud, I., 2009. Occurrence of freshwater macrophytes in the catchments of the Parramatta River, Lane Cove River and Middle Harbour Creek, 2007 – 2008. 75pp.
- No. 110 Gilligan, D., Vey, A. and Asmus, M., 2009. Identifying drought refuges in the Wakool system and assessing status of fish populations and water quality before, during and after the provision of environmental, stock and domestic flows. 56pp.

ISSN 1837-2112 (Industry & Investment NSW – Fisheries Final Report Series)

- No. 111 Gray, C.A., Scandol, J.P., Steffe, A.S. and Ferrell, D.J., 2009. Australian Society for Fish Biology Annual Conference & Workshop 2008: Assessing Recreational Fisheries; Current and Future Challenges. 54pp.
- No. 112 Otway, N.M. Storrie, M.T., Loudon, B.M. and Gilligan, J.J., 2009. Documentation of depth-related migratory movements, localised movements at critical habitat sites and the effects of scuba diving for the east coast grey nurse shark population. 90pp.
- No. 113 Creese, R.G., Glasby, T.M., West, G. and Gallen, C., 2009. Mapping the habitats of NSW estuaries. 95pp.
- No. 114 Macbeth, W.G., Geraghty, P.T., Peddemors, V.M. and Gray, C.A., 2009. Observer-based study of targeted commercial fishing for large shark species in waters off northern New South Wales. 82pp.
- No. 115 Scandol, J.P., Ives, M.C. and Lockett, M.M., 2009. Development of national guidelines to improve the application of risk-based methods in the scope, implementation and interpretation of stock assessments for data-poor species. 186pp.
- No. 116 Baumgartner, L., Bettanin, M., McPherson, J., Jones, M., Zampatti, B. and Kathleen Beyer., 2009. Assessment of an infrared fish counter (Vaki Riverwatcher) to quantify fish migrations in the Murray-Darling Basin. 47pp.
- No. 117 Astles, K., West, G., and Creese, R.G., 2010. Estuarine habitat mapping and geomorphic characterisation of the Lower Hawkesbury river and Pittwater estuaries. 229pp.
- No. 118 Gilligan, D., Jess, L., McLean, G., Asmus, M., Wooden, I., Hartwell, D., McGregor, C., Stuart, I., Vey, A., Jefferies, M., Lewis, B. and Bell, K., 2010. Identifying and implementing targeted carp control options for the Lower Lachlan Catchment. 126pp.
- No. 119 Montgomery, S.S., Walsh, C.T., Kesby, C.L and Johnson, D.D., 2010. Studies on the growth and mortality of school prawns. 90pp.
- No. 120 Liggins, G.W. and Upston, J., 2010. Investigating and managing the *Perkinsus*-related mortality of blacklip abalone in NSW. 182pp.
- No. 121 Knight, J., 2010. The feasibility of excluding alien redfin perch from Macquarie perch habitat in the Hawkesbury-Nepean Catchment. 53pp.
- No. 122 Ghosn, D., Steffe, A., Murphy, J., 2010. An assessment of the effort and catch of shore and boat-based recreational fishers in the Sydney Harbour estuary over the 2007/08 summer period. 60pp.
- No. 123 Rourke, M. and Gilligan, D., 2010. Population genetic structure of freshwater catfish (*Tandanus tandanus*) in the Murray-Darling Basin and coastal catchments of New South Wales: Implications for future re-stocking programs. 74pp.
- No. 124 Tynan, R., Bunter, K. and O'Connor, W., 2010. Industry Management and Commercialisation of the Sydney Rock Oyster Breeding Program. 21pp.

- No. 125 Lowry, M., Folpp, H., Gregson, M. and McKenzie, R., 2010. Assessment of artificial reefs in Lake Macquarie NSW. 47pp.
- No. 126 Howell, T. and Creese, R., 2010. Freshwater fish communities of the Hunter, Manning, Karuah and Macquarie-Tuggerah catchments: a 2004 status report. 93pp.
- No. 127 Gilligan, D., Rodgers, M., McGarry, T., Asmus, M. and Pearce, L., 2010. The distribution and abundance of two endangered fish species in the NSW Upper Murray Catchment. 34pp.
- No. 128 Gilligan, D., McGarry, T. and Carter, S., 2010. A scientific approach to developing habitat rehabilitation strategies in aquatic environments: A case study on the endangered Macquarie perch (*Macquaria australasica*) in the Lachlan catchment. 61pp.
- No. 129 Stewart, J., Hughes, J., McAllister, J., Lyle, J. and MacDonald, M., 2011. Australian salmon (*Arripis trutta*): Population structure, reproduction, diet and composition of commercial and recreational catches. 257 pp.

ISSN 1837-2112 (Fisheries Final Report Series)

- No. 130 Boys, C., Glasby, T., Kroon, F., Baumgartner, L., Wilkinson, K., Reilly, G. and Fowler, T., 2011. Case studies in restoring connectivity of coastal aquatic habitats: floodgates, box culvert and rock-ramp fishway. 75pp.
- No. 131 Steffe, A.S. and Murphy, J.J., 2011. Recreational fishing surveys in the Greater Sydney Region. 122pp.
- No. 132 Robbins, W.D., Peddemors, V.M. and Kennelly, S.J., 2012. Assessment of shark sighting rates by aerial beach patrols. 38pp.
- No. 133 Boys, C.A. and Williams, R.J., 2012. Fish and decapod assemblages in Kooragang Wetlands: the impact of tidal restriction and responses to culvert removal. 80pp.
- No. 134 Boys, C.A., Baumgartner, L., Rampano, B., Robinson, W., Alexander, T., Reilly, R., Roswell, M., Fowler, T., and Lowry, M., 2012. Development of fish screening criteria for water diversions in the Murray-Darling Basin. 62pp.